



DECOSCAPE

PERFECT INTEGRATION OF LIGHTS AND SPACE

# DECOSCAPE

Decoscape Lighting is an architectural lighting brand part of the Luceco portfolio a global leader in design, manufacture and supply of lighting systems for the specification sector. From off the shelf products to tailored solutions, Luceco provides a comprehensive product portfolio with full lighting design and technical support.

Luceco continually invests in environmentally friendly responsible technology and innovation, its brands offer a leading portfolio of thoughtfully designed and digitally made products. From task and emergency to ambient architectural, employing the latest in energy-saving and sustainable technology.

Major sectors served residential, commercial, office, Healthcare, education, retail, industrial, public sector, Street and highway.

Our portfolio of respected lighting brands, include:



*“Operating sustainably is a key part of the Group’s culture and is reflected within our Purpose, Mission and Strategy; where we have made sustainability a central pillar of the Group’s success”*

**John Hornby**  
Chief Executive Officer

# Ultra-thin two-wire track

SURFACE MOUNTED



WIRE QUANTITY	two-wire
INPUT VOLTAGE	12-48V
INSTALLATION METHOD	Surface mounte
MATERIAL	Aluminum+Copper
COLOUR	Black/White

PRODUCT DRAWING

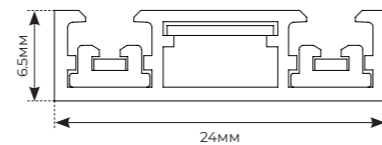

# Straight joint for ultra-thin track

ACCESSORY



TRACK USED	Ultra-thin track
MATERIAL	Flame-retardant PC
COLOUR	Black/White
INPUT VOLTAGE	DC48V

PRODUCT DRAWING

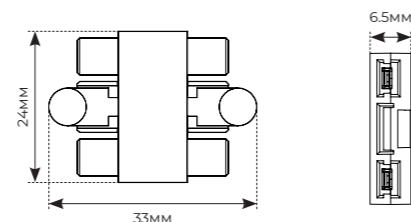

# T-joint for ultra-thin track

ACCESSORY



TRACK USED	Ultra-thin track
MATERIAL	Flame-retardant PC
COLOUR	Black/White
INPUT VOLTAGE	DC48V

PRODUCT DRAWING

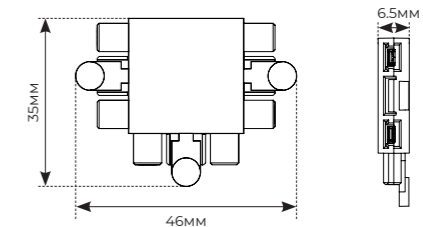

# Vertical connector for ultra-thin track

ACCESSORY



TRACK USED	Ultra-thin track
MATERIAL	Flame-retardant PC
COLOUR	Black/White
INPUT VOLTAGE	DC48V

PRODUCT DRAWING

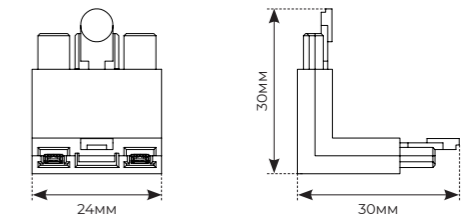

# Horizontal connector for ultra-thin track

ACCESSORY



TRACK USED	Ultra-thin track
MATERIAL	Flame-retardant PC
COLOUR	Black/White
INPUT VOLTAGE	DC48V

PRODUCT DRAWING

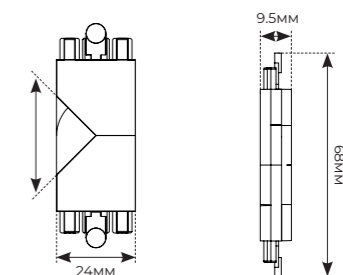

## Cross joint for ultra-thin track

ACCESSORY



PRODUCT DRAWING

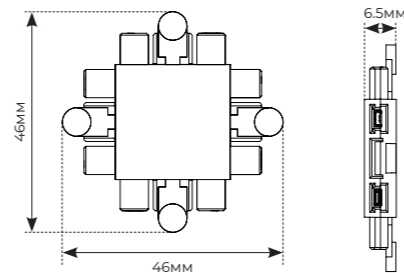

TRACK USED	Ultra-thin track
MATERIAL	Flame-retardant PC
COLOUR	Black /White
INPUT VOLTAGE	DC48V

## Input connector box for ultra-thin track

SURFACE MOUNTED



PRODUCT DRAWING

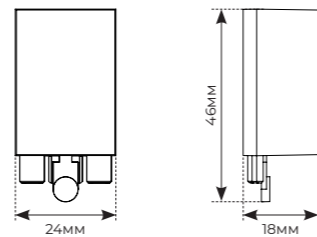

TRACK USED	Ultra-thin track
MATERIAL	Flame-retardant PC
COLOUR	Black /White
INPUT VOLTAGE	DC48V

## Cut off after splicing joint

ACCESSORY

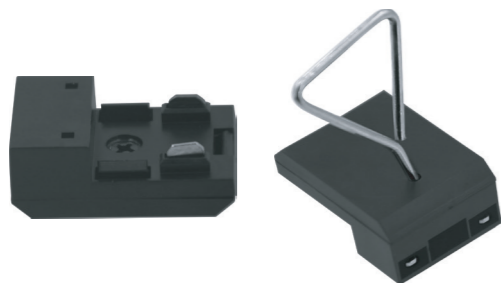

PRODUCT DRAWING

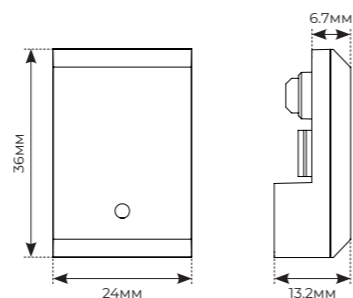

TRACK USED	Ultra-thin track
MATERIAL	Flame-retardant PC
COLOUR	Black /White
INPUT VOLTAGE	DC48V

## Ultra-thin driver



INPUT VOLTAGE	220-240VAC
PROTECTIONS	SCP/OLP/OVP
POWER FACTOR	>0.95
EFFICIENCY	≥88%
WORK INDICATING LAMP	Yes
WARRANTY	3 Year

OUTPUT	CONSTANT VOLTAGE	48VDC
	CURRENT RANGE	0-2.08A
	VOLTAGE ACCURACY	±5%
	OUTPUT HF CURRENT RIPPLE (≥1KHz)	±4%
	OUTPUT LF CURRENT RIPPLE (≤120Hz)	±4%
	SVM	≤0.4
INPUT	PST	≤1
	EFFICIENCY (TYP.)	≥88%
	RATED INPUT VOLTAGE	220-240VAC
	RANGE OF INPUT VOLTAGE	198-264VAC
	FREQUENCY (Hz)	50/60 Hz
	DISPLACEMENT FACTOR	≥0.9
	POWER FACTOR	>0.95
	INPUT CURRENT MAX	0.65 A MAX
	START-UP TIME	<0.5 S
	NO LOAD POWER	≤0.5W
THD (TYP.)	<10%	
PROTECTION	OVER LOAD PROTECTION	105-150% rated output power YES/Auto Resume
	CIRCUIT PROTECTION	YES/Auto Resume
	OVER TEMPERATURE PROTECTION	YES/Auto Resume
ENVIRONMENT	TEMPERATURE	-20°C...+40°C
	HUMIDITY	20%-90%RH
	Tc	80°C
	STORAGE TEMPERATURE	-20°C...+80°C
SURFACE	LIFE TIME	≥30,000h @ Tc=80°C, full load
STANDARDS	DIMENSION	285*26.6*26mm
		EN 61347-1;EN61347-2-13;EN62384;EN55015;EN61000-3-2; EN61000-3-3;EN 61547

PRODUCT DRAWING



# Linear magnetic spotlights



POWER	6W
LUMEN	520Lm
BEAM ANGLE	15°/24°/36°
TEMPERATURE	-20°C~45°C
CCT CHANGE	3000K/3500K/4000K/6500K
CRI	Ra>90
OPTICAL	PMMA Optical Lens
DRIVER	DC 3V-42V
INPUT VOLTAGE	DC48V
LED CHIP	OSRAM 3030
PRODUCT SIZE	L120*W24*H26mm
TRACK USED	Ultra-thin track
IP RATING	IP20
MATERIAL	Die-cast Aluminum
FINISH	White/Black

PRODUCT DRAWING

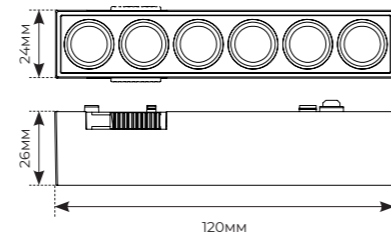

POWER	6W
LUMEN	520Lm
BEAM ANGLE	15°/24°/36°
TEMPERATURE	-20°C~45°C
CCT CHANGE	3000K/3500K/4000K/6500K
CRI	Ra>90
OPTICAL	PMMA Optical Lens
DRIVER	DC 3V-42V
INPUT VOLTAGE	DC48V
LED CHIP	OSRAM 3030
PRODUCT SIZE	L120*W24*H26mm
TRACK USED	Ultra-thin track
IP RATING	IP20
MATERIAL	Die-cast Aluminum
FINISH	White/Black

PRODUCT DRAWING

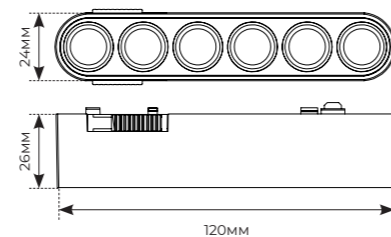

POWER	12W
LUMEN	1050LM
BEAM ANGLE	15°/24°/36°
TEMPERATURE	-20°C~45°C
CCT CHANGE	3000K/3500K/4000K/6500K
CRI	Ra>90
OPTICAL	PMMA Optical Lens
DRIVER	DC 3V-42V
INPUT VOLTAGE	DC48V
LED CHIP	OSRAM 3030
PRODUCT SIZE	L236*W24*H26mm
TRACK USED	Ultra-thin track
IP RATING	IP20
MATERIAL	Die-cast Aluminum
FINISH	White/Black

PRODUCT DRAWING

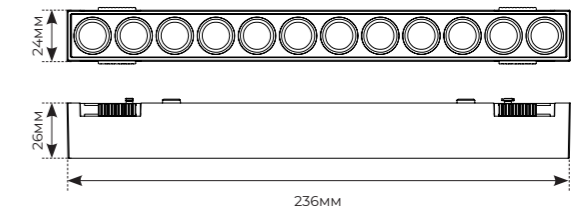

POWER	12W
LUMEN	1050LM
BEAM ANGLE	15°/24°/36°
TEMPERATURE	-20°C~45°C
CCT CHANGE	3000K/3500K/4000K/6500K
CRI	Ra>90
OPTICAL	PMMA Optical Lens
DRIVER	DC 3V-42V
INPUT VOLTAGE	DC48V
LED CHIP	OSRAM 3030
PRODUCT SIZE	L236*W24*H26mm
TRACK USED	Ultra-thin track
IP RATING	IP20
MATERIAL	Die-cast Aluminum
FINISH	White/Black

PRODUCT DRAWING

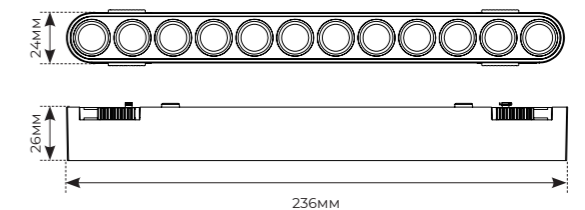

# Linear magnetic spotlights



POWER	6W
LUMEN	520Lm
BEAM ANGLE	15°/24°/36°
TEMPERATURE	-20°C~45°C
CCT CHANGE	3000K/3500K/4000K/6500K
CRI	Ra>90
OPTICAL	PMMA Optical Lens
DRIVER	DC 3V-42V
INPUT VOLTAGE	DC48V
LED CHIP	OSRAM 3030
PRODUCT SIZE	L120*W24*H26mm
TRACK USED	Ultra-thin track
IP RATING	IP20
MATERIAL	Die-cast Aluminum
FINISH	White/Black

PRODUCT DRAWING

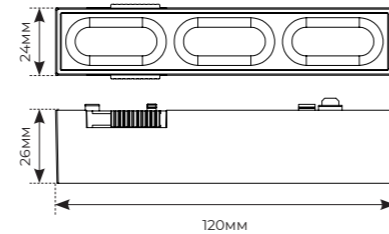

POWER	6W
LUMEN	520Lm
BEAM ANGLE	15°/24°/36°
TEMPERATURE	-20°C~45°C
CCT CHANGE	3000K/3500K/4000K/6500K
CRI	Ra>90
OPTICAL	PMMA Optical Lens
DRIVER	DC 3V-42V
INPUT VOLTAGE	DC48V
LED CHIP	OSRAM 3030
PRODUCT SIZE	L120*W24*H26mm
TRACK USED	Ultra-thin track
IP RATING	IP20
MATERIAL	Die-cast Aluminum
FINISH	White/Black

PRODUCT DRAWING

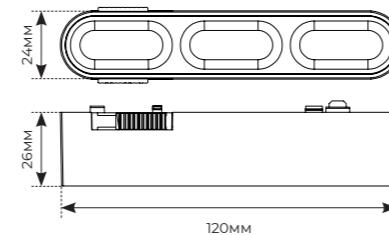

POWER	12W
LUMEN	1050LM
BEAM ANGLE	15°/24°/36°
TEMPERATURE	-20OC~45OC
CCT CHANGE	3000K/3500K/4000K/6500K
CRI	Ra>90
OPTICAL	PMMA Optical Lens
DRIVER	DC 3V-42V
INPUT VOLTAGE	DC48V
LED CHIP	OSRAM 3030
PRODUCT SIZE	L236*W24*H26mm
TRACK USED	Ultra-thin track
IP RATING	IP20
MATERIAL	Die-cast Aluminum
FINISH	White/Black

PRODUCT DRAWING

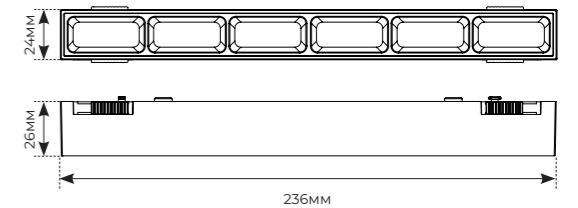

POWER	12W
LUMEN	1050LM
BEAM ANGLE	15°/24°/36°
TEMPERATURE	-20OC~45OC
CCT CHANGE	3000K/3500K/4000K/6500K
CRI	Ra>90
OPTICAL	PMMA Optical Lens
DRIVER	DC 3V-42V
INPUT VOLTAGE	DC48V
LED CHIP	OSRAM 3030
PRODUCT SIZE	L236*W24*H26mm
TRACK USED	Ultra-thin track
IP RATING	IP20
MATERIAL	Die-cast Aluminum
FINISH	White/Black

PRODUCT DRAWING

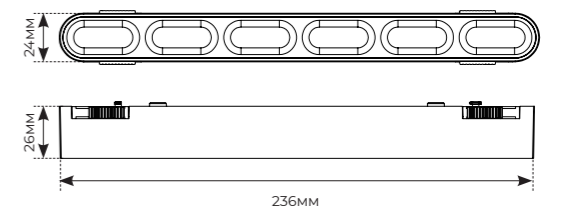

# Linear magnetic spotlights

POWER	12W
LUMEN	840Lm
BEAM ANGLE	110°
TEMPERATURE	-20°C~45°C
CCT CHANGE	3000K/3500K/4000K/6500K
CRI	Ra>80
OPTICAL	PC Optical Difuser
DRIVER	DC 3V-42V
INPUT VOLTAGE	DC48V
LED CHIP	OSRAM 3030
PRODUCT SIZE	L300*W24*H25mm
TRACK USED	Ultra-thin track
IP RATING	IP20
MATERIAL	Die-cast Aluminum
FINISH	White/Black



PRODUCT DRAWING

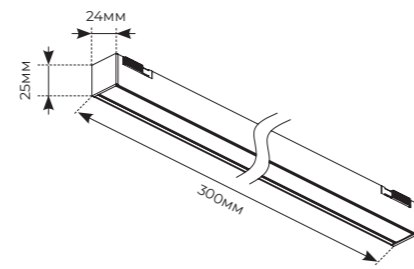

POWER	30W
LUMEN	2100Lm
BEAM ANGLE	110°
TEMPERATURE	-20°C~45°C
CCT CHANGE	3000K/3500K/4000K/6500K
CRI	Ra>80
OPTICAL	PC Optical Difuser
DRIVER	DC 3V-42V
INPUT VOLTAGE	DC48V
LED CHIP	OSRAM 3030
PRODUCT SIZE	L900*W24*H25mm
TRACK USED	Ultra-thin track
IP RATING	IP20
MATERIAL	Die-cast Aluminum
FINISH	White/Black



PRODUCT DRAWING

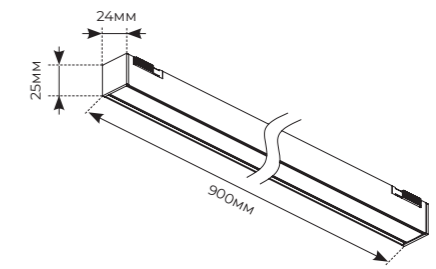

POWER	24W
LUMEN	1680Lm
BEAM ANGLE	110°
TEMPERATURE	-20°C~45°C
CCT CHANGE	3000K/3500K/4000K/6500K
CRI	Ra>80
OPTICAL	PC Optical Difuser
DRIVER	DC 3V-42V
INPUT VOLTAGE	DC48V
LED CHIP	OSRAM 3030
PRODUCT SIZE	L600*W24*H25mm
TRACK USED	Ultra-thin track
IP RATING	IP20
MATERIAL	Die-cast Aluminum
FINISH	White/Black



PRODUCT DRAWING

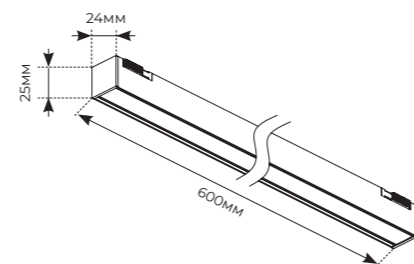

# Cylindrical magnetic spotlights

POWER	7W
LUMEN	470Lm
BEAM ANGLE	15°/24°/36°
TEMPERATURE	-20°C~45°C
CCT CHANGE	3000K/3500K/4000K/6500K
CRI	Ra>90
OPTICAL	PMMA Optical Lens
DRIVER	DC 3V-42V
INPUT VOLTAGE	DC48V
LED CHIP	Luminus
PRODUCT SIZE	Ø35*80mm
VERTICAL ROTATION ANGLE	90°
ANGLE OF HORIZONTAL ROTATION	350°
TRACK USED	Ultra-thin track
IP RATING	IP20
MATERIAL	Die-cast Aluminum
FINISH	White/Black



PRODUCT DRAWING

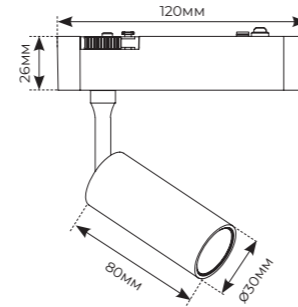

POWER	15W
LUMEN	1050Lm
BEAM ANGLE	15°/24°/36°
TEMPERATURE	-20°C~45°C
CCT CHANGE	3000K/3500K/4000K/6500K
CRI	Ra>90
OPTICAL	PMMA Optical Lens
DRIVER	DC 3V-42V
INPUT VOLTAGE	DC48V
LED CHIP	Luminus
PRODUCT SIZE	Ø55*113mm
VERTICAL ROTATION ANGLE	90°
ANGLE OF HORIZONTAL ROTATION	350°
TRACK USED	Ultra-thin track
IP RATING	IP20
MATERIAL	Die-cast Aluminum
FINISH	White/Black



PRODUCT DRAWING

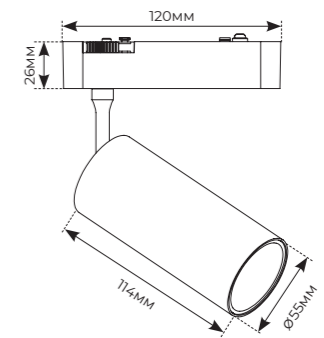

POWER	12W
LUMEN	790Lm
BEAM ANGLE	15°/24°/36°
TEMPERATURE	-20°C~45°C
CCT CHANGE	3000K/3500K/4000K/6500K
CRI	Ra>90
OPTICAL	PMMA Optical Lens
DRIVER	DC 3V-42V
INPUT VOLTAGE	DC48V
LED CHIP	Luminus
PRODUCT SIZE	Ø45*103mm
VERTICAL ROTATION ANGLE	90°
ANGLE OF HORIZONTAL ROTATION	350°
TRACK USED	Ultra-thin track
IP RATING	IP20
MATERIAL	Die-cast Aluminum
FINISH	White/Black



PRODUCT DRAWING

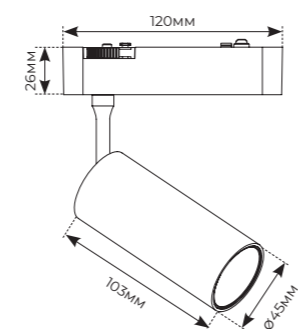

POWER	24W
LUMEN	1750Lm
BEAM ANGLE	15°/24°/36°
TEMPERATURE	-20°C~45°C
CCT CHANGE	3000K/3500K/4000K/6500K
CRI	Ra>90
OPTICAL	PMMA Optical Lens
DRIVER	DC 3V-42V
INPUT VOLTAGE	DC48V
LED CHIP	Luminus
PRODUCT SIZE	Ø65*133mm
VERTICAL ROTATION ANGLE	90°
ANGLE OF HORIZONTAL ROTATION	350°
TRACK USED	Ultra-thin track
IP RATING	IP20
MATERIAL	Die-cast Aluminum
FINISH	White/Black



PRODUCT DRAWING

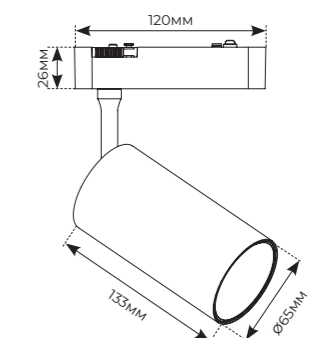



# Cylindrical magnetic spotlights



PRODUCT DRAWING

POWER	7W
LUMEN	450Lm
BEAM ANGLE	15°/24°/36°
TEMPERATURE	-20°C~45°C
CCT CHANGE	3000K/3500K/4000K/6500K
CRI	Ra>90
OPTICAL	PMMA Optical Lens
DRIVER	DC 3V-42V
INPUT VOLTAGE	DC48V
LED CHIP	Bridgelux COB
PRODUCT SIZE	Ø32*70mm
VERTICAL ROTATION ANGLE	90°
ANGLE OF HORIZONTAL ROTATION	350°
TRACK USED	Ultra-thin track
IP RATING	IP20
MATERIAL	Die-cast Aluminum
FINISH	White/Black

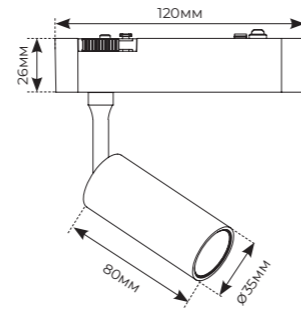

PRODUCT DRAWING

POWER	17W
LUMEN	930Lm
BEAM ANGLE	15°/24°/36°
TEMPERATURE	-20°C~45°C
CCT CHANGE	3000K/3500K/4000K/6500K
CRI	Ra>90
OPTICAL	PMMA Optical Lens
DRIVER	DC 3V-42V
INPUT VOLTAGE	DC48V
LED CHIP	Luminus
PRODUCT SIZE	Ø50*100mm
VERTICAL ROTATION ANGLE	90°
ANGLE OF HORIZONTAL ROTATION	350°
TRACK USED	Ultra-thin track
IP RATING	IP20
MATERIAL	Die-cast Aluminum
FINISH	White/Black

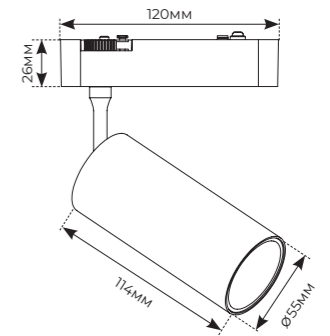

PRODUCT DRAWING

POWER	12W
LUMEN	720Lm
BEAM ANGLE	15°/24°/36°
TEMPERATURE	-20°C~45°C
CCT CHANGE	3000K/3500K/4000K/6500K
CRI	Ra>90
OPTICAL	PMMA Optical Lens
DRIVER	DC 3V-42V
INPUT VOLTAGE	DC48V
LED CHIP	Luminus
PRODUCT SIZE	Ø40*85mm
VERTICAL ROTATION ANGLE	90°
ANGLE OF HORIZONTAL ROTATION	350°
TRACK USED	Ultra-thin track
IP RATING	IP20
MATERIAL	Die-cast Aluminum
FINISH	White/Black

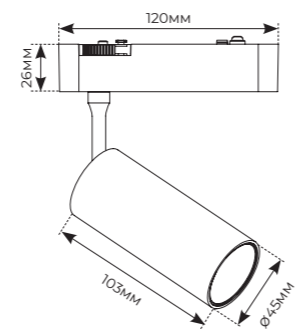

PRODUCT DRAWING

POWER	24W
LUMEN	1440Lm
BEAM ANGLE	15°/24°/36°
TEMPERATURE	-20°C~45°C
CCT CHANGE	3000K/3500K/4000K/6500K
CRI	Ra>90
OPTICAL	PMMA Optical Lens
DRIVER	DC 3V-42V
INPUT VOLTAGE	DC48V
LED CHIP	Luminus
PRODUCT SIZE	Ø60*125mm
VERTICAL ROTATION ANGLE	90°
ANGLE OF HORIZONTAL ROTATION	350°
TRACK USED	Ultra-thin track
IP RATING	IP20
MATERIAL	Die-cast Aluminum
FINISH	White/Black

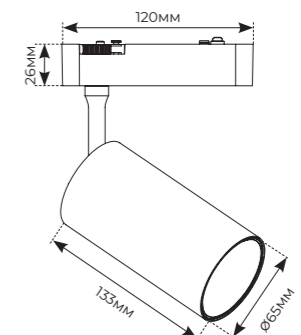

## Circular magnetic spotlights

POWER	12W
LUMEN	840Lm
BEAM ANGLE	15°/24°/36°
TEMPERATURE	-20°C~45°C
CCT CHANGE	3000K/3500K/4000K/6500K
CRI	Ra>90
OPTICAL	PMMA Optical Lens
DRIVER	DC 3V-42V
INPUT VOLTAGE	DC48V
LED CHIP	Bridgelux COB
PRODUCT SIZE	Ø60*H111mm
VERTICAL ROTATION ANGLE	90°
ANGLE OF HORIZONTAL ROTATION	350°
TRACK USED	Ultra-thin track
IP RATING	IP20
MATERIAL	Die-cast Aluminum
FINISH	White/Black



PRODUCT DRAWING

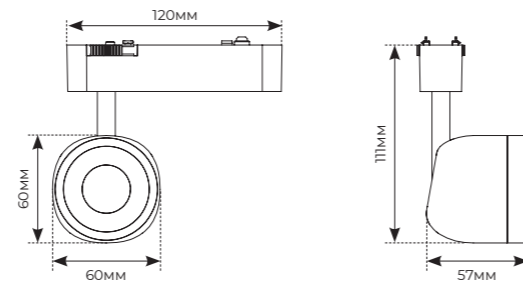

POWER	24W
LUMEN	1680Lm
BEAM ANGLE	15°/24°/36°
TEMPERATURE	-20°C~45°C
CCT CHANGE	3000K/3500K/4000K/6500K
CRI	Ra>90
OPTICAL	PMMA Optical Lens
DRIVER	DC 3V-42V
INPUT VOLTAGE	DC48V
LED CHIP	Luminus
PRODUCT SIZE	Ø80*H120mm
VERTICAL ROTATION ANGLE	90°
ANGLE OF HORIZONTAL ROTATION	350°
TRACK USED	Ultra-thin track
IP RATING	IP20
MATERIAL	Die-cast Aluminum
FINISH	White/Black



PRODUCT DRAWING

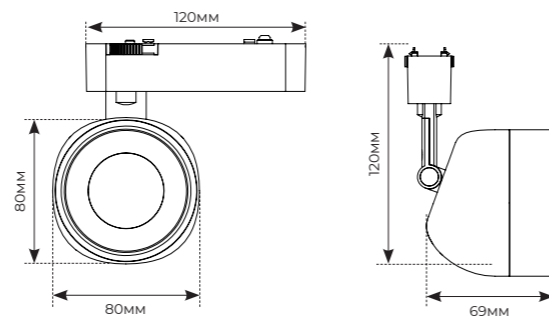

## Circular magnetic bevel spotlights

POWER	12W
LUMEN	840Lm
BEAM ANGLE	15°/24°/36°
TEMPERATURE	-20°C~45°C
CCT CHANGE	3000K/3500K/4000K/6500K
CRI	Ra>90
OPTICAL	PMMA Optical Lens
DRIVER	DC 3V-42V
INPUT VOLTAGE	DC48V
LED CHIP	Luminus
PRODUCT SIZE	Ø60*H96mm
VERTICAL ROTATION ANGLE	90°
ANGLE OF HORIZONTAL ROTATION	350°
TRACK USED	Ultra-thin track
IP RATING	IP20
MATERIAL	Die-cast Aluminum
FINISH	White/Black



PRODUCT DRAWING

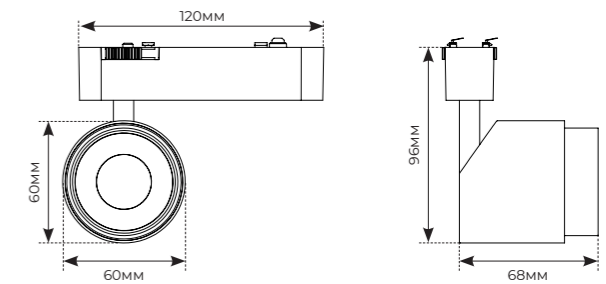

POWER	24W
LUMEN	1680Lm
BEAM ANGLE	15°/24°/36°
TEMPERATURE	-20°C~45°C
CCT CHANGE	3000K/3500K/4000K/6500K
CRI	Ra>90
OPTICAL	PMMA Optical Lens
DRIVER	DC 3V-42V
INPUT VOLTAGE	DC48V
LED CHIP	Luminus
PRODUCT SIZE	Ø80*H132mm
VERTICAL ROTATION ANGLE	90°
ANGLE OF HORIZONTAL ROTATION	350°
TRACK USED	Ultra-thin track
IP RATING	IP20
MATERIAL	Die-cast Aluminum
FINISH	White/Black



PRODUCT DRAWING

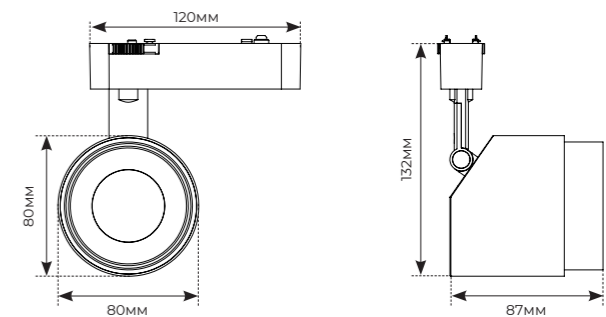

## Circular wall wash spotlights



POWER	12W
LUMEN	840Lm
BEAM ANGLE	15°/24°/36°
TEMPERATURE	-20°C~45°C
CCT CHANGE	3000K/3500K/4000K/6500K
CRI	Ra>90
OPTICAL	PMMA Optical Lens
DRIVER	DC 3V-42V
INPUT VOLTAGE	DC48V
LED CHIP	Bridgelux COB
PRODUCT SIZE	Ø60*H95mm
VERTICAL ROTATION ANGLE	90°
ANGLE OF HORIZONTAL ROTATION	350°
TRACK USED	Ultra-thin track
IP RATING	IP20
MATERIAL	Die-cast Aluminum
FINISH	White/Black

PRODUCT DRAWING

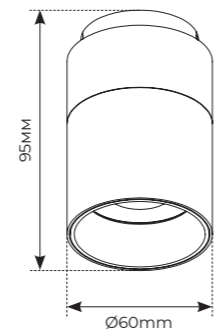

POWER	24W
LUMEN	1680Lm
BEAM ANGLE	15°/24°/36°
TEMPERATURE	-20°C~45°C
CCT CHANGE	3000K/3500K/4000K/6500K
CRI	Ra>90
OPTICAL	PMMA Optical Lens
DRIVER	DC 3V-42V
INPUT VOLTAGE	DC48V
LED CHIP	Luminus
PRODUCT SIZE	Ø80*H107mm
VERTICAL ROTATION ANGLE	90°
ANGLE OF HORIZONTAL ROTATION	350°
TRACK USED	Ultra-thin track
IP RATING	IP20
MATERIAL	Die-cast Aluminum
FINISH	White/Black

PRODUCT DRAWING

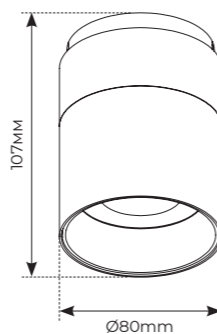

## Square wall wash spotlights



POWER	8W
LUMEN	560Lm
BEAM ANGLE	15°/24°/36°
TEMPERATURE	-20°C~45°C
CCT CHANGE	3000K/3500K/4000K/6500K
CRI	Ra>90
OPTICAL	PMMA Optical Lens
DRIVER	DC 3V-42V
INPUT VOLTAGE	DC48V
LED CHIP	Luminus
PRODUCT SIZE	L53*W53*H70mm
VERTICAL ROTATION ANGLE	90°
ANGLE OF HORIZONTAL ROTATION	350°
TRACK USED	Ultra-thin track
IP RATING	IP20
MATERIAL	Die-cast Aluminum
FINISH	White/Black

PRODUCT DRAWING

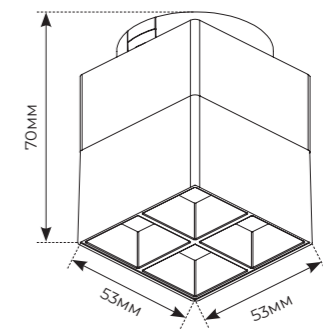

POWER	18W
LUMEN	1260Lm
BEAM ANGLE	15°/24°/36°
TEMPERATURE	-20°C~45°C
CCT CHANGE	3000K/3500K/4000K/6500K
CRI	Ra>90
OPTICAL	PMMA Optical Lens
DRIVER	DC 3V-42V
INPUT VOLTAGE	DC48V
LED CHIP	Luminus
PRODUCT SIZE	L78*W78*H77mm
VERTICAL ROTATION ANGLE	90°
ANGLE OF HORIZONTAL ROTATION	350°
TRACK USED	Ultra-thin track
IP RATING	IP20
MATERIAL	Die-cast Aluminum
FINISH	White/Black

PRODUCT DRAWING

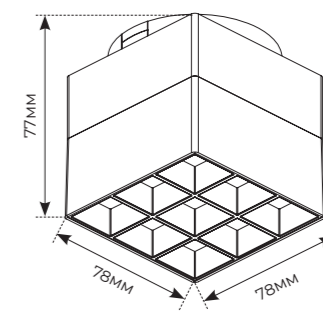

# Ultra-thin pendant

POWER	8W
LUMEN	480Lm
BEAM ANGLE	110°
TEMPERATURE	-20°C~45°C
CCT CHANGE	3000K/3500K/4000K/6500K
CRI	Ra>90
OPTICAL	Diffusion plate
DRIVER	DC 3V-42V
INPUT VOLTAGE	DC48V
LED CHIP	OSRAM 3030
PRODUCT SIZE	D150*147mm
LENGTH OF SUSPENSION LINE	1200mm
TRACK USED	Ultra-thin track
IP RATING	IP20
MATERIAL	Metal+Glass
FINISH	Smoky Gray/Gold

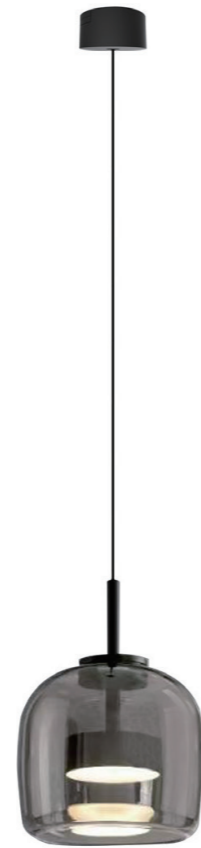

POWER	8W
LUMEN	180Lm
BEAM ANGLE	110°
TEMPERATURE	-20°C~45°C
CCT CHANGE	3000K/3500K/4000K/6500K
CRI	Ra>90
OPTICAL	Diffusion plate
DRIVER	DC 3V-42V
INPUT VOLTAGE	DC48V
LED CHIP	OSRAM 3030
PRODUCT SIZE	D100*97mm
LENGTH OF SUSPENSION LINE	1200mm
TRACK USED	Ultra-thin track
IP RATING	IP20
MATERIAL	Metal+Glass
FINISH	Smoky Gray/Amber/Clear



POWER	8W
LUMEN	480Lm
BEAM ANGLE	110°
TEMPERATURE	-20°C~45°C
CCT CHANGE	3000K/3500K/4000K/6500K
CRI	Ra>90
OPTICAL	Diffusion plate
DRIVER	DC 3V-42V
INPUT VOLTAGE	DC48V
LED CHIP	OSRAM 3030
PRODUCT SIZE	D230*70mm
LENGTH OF SUSPENSION LINE	1200mm
TRACK USED	Ultra-thin track
IP RATING	IP20
MATERIAL	Metal+Glass
FINISH	Smoky Gray/Amber/Clear



POWER	8W
LUMEN	350Lm
BEAM ANGLE	110°
TEMPERATURE	-20°C~45°C
CCT CHANGE	3000K/3500K/4000K/6500K
CRI	Ra>90
OPTICAL	Diffusion plate
DRIVER	DC 3V-42V
INPUT VOLTAGE	DC48V
LED CHIP	OSRAM 3030
PRODUCT SIZE	D250*H280mm
LENGTH OF SUSPENSION LINE	1200mm
TRACK USED	Ultra-thin track
IP RATING	IP20
MATERIAL	Metal+Glass
FINISH	Smoky Gray/Amber/Clear



# Ultra-thin chandelier

POWER	8W
LUMEN	350Lm
BEAM ANGLE	110°
TEMPERATURE	-20°C~45°C
CCT CHANGE	3000K/3500K/4000K
CRI	Ra>90
OPTICAL	Diffusion plate
DRIVER	DC 3V-42V
INPUT VOLTAGE	DC48V
LED CHIP	OSRAM 3030
PRODUCT SIZE	Ø230*H290mm
LENGTH OF SUSPENSION LINE	1200mm
TRACK USED	Ultra-thin track
IP RATING	IP20
MATERIAL	Metal+Glass
FINISH	Smoky Gray/Gold

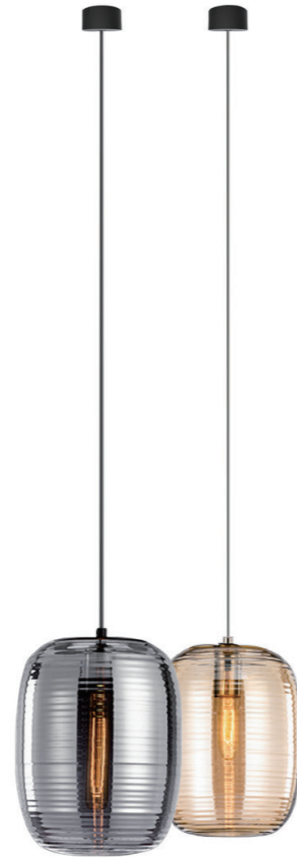

POWER	6W
LUMEN	600LM: 15°/24°/36°; 570LM: 60°
BEAM ANGLE	15°/24°/36°/60°
TEMPERATURE	-20°C~45°C
CCT CHANGE	3000K/3500K/4000K
CRI	Ra>90
OPTICAL	PMMA Optical Lens
DRIVER	DC 3V-42V
INPUT VOLTAGE	DC48V
LED CHIP	OSRAM 3030
PRODUCT SIZE	Ø130*H76mm
LENGTH OF SUSPENSION LINE	1100mm
TRACK USED	Ultra-thin track
IP RATING	IP20
MATERIAL	Metal+Glass
FINISH	Black/White/Chrome



POWER	6W
LUMEN	510LM: 18°/24°; 450LM: 36°; 380LM: 60°
BEAM ANGLE	110°
TEMPERATURE	-20°C~45°C
CCT CHANGE	3000K/3500K/4000K
CRI	Ra>90
OPTICAL	Diffusion plate
DRIVER	DC 3V-42V
INPUT VOLTAGE	DC48V
LED CHIP	OSRAM 3030
PRODUCT SIZE	D230*70mm
LENGTH OF SUSPENSION LINE	1200mm
TRACK USED	Ultra-thin track
IP RATING	IP20
MATERIAL	Metal+Glass
FINISH	Smoky Gray/Amber/Clear



POWER	10W
LUMEN	350Lm
BEAM ANGLE	15°/24°/36°
TEMPERATURE	-20°C~45°C
CCT CHANGE	3000K/3500K/4000K/6500K
CRI	Ra>90
OPTICAL	Diffusion plate
DRIVER	DC 3V-42V
INPUT VOLTAGE	DC48V
LED CHIP	Bridgelux COB
TRACK USED	Ultra-thin track
IP RATING	IP20
MATERIAL	Die-cast Aluminum
FINISH	Black



# Wall luminaires



POWER	5W
LUMEN	400Lm
TEMPERATURE	-20°C~45°C
CCT CHANGE	3000K/3500K/4000K
CRI	Ra>90
OPTICAL	PC diffuser
DRIVER	DC 3V-42V
INPUT VOLTAGE	DC48V
LED CHIP	San'an 2835
PRODUCT SIZE	D350*H195mm
TRACK USED	Ultra-thin track
IP RATING	IP20
MATERIAL	Aluminum
FINISH	Wood grain and White/Black and White/White



POWER	12W
LUMEN	960Lm
TEMPERATURE	-20°C~45°C
CCT CHANGE	3000K/4000K/6000K
CRI	Ra>90
OPTICAL	Diffusion plate
DRIVER	DC 3V-42V
INPUT VOLTAGE	DC48V
LED CHIP	San'an 2835
PRODUCT SIZE	D600*H195
TRACK USED	Ultra-thin track
IP RATING	IP20
MATERIAL	Aluminum
FINISH	Wood grain and White/Black and White/White

# Wall luminaires Wall luminaires



POWER	8W
LUMEN	640Lm
BEAM ANGLE	15°/24°/36°/60°
TEMPERATURE	-20°C~45°C
CCT CHANGE	3000K/4000K/6000K
CRI	Ra>90
OPTICAL	PC diffuser
DRIVER	DC 3V-42V
INPUT VOLTAGE	DC48V
LED CHIP	San'an 2835
PRODUCT SIZE	L620*W100*H95mm
LENGTH OF SUSPENSION LINE	1100mm
TRACK USED	Ultra-thin track
IP RATING	IP20
MATERIAL	Iron tube+PMMA tube
FINISH	Gold

# Ceiling lamp



POWER	12W
LUMEN	960Lm
BEAM ANGLE	15°/24°/36°
TEMPERATURE	-20°C~45°C
CCT CHANGE	3000K/4000K/6000K
CRI	Ra>90
OPTICAL	Diffusion plate
DRIVER	DC 3V-42V
INPUT VOLTAGE	DC48V
LED CHIP	San'an 2835
PRODUCT SIZE	Ø300*H160mm
TRACK USED	Ultra-thin track
IP RATING	IP20
MATERIAL	Aluminium cover with painting
FINISH	Black / White / Grey (Any painting colour optional)



POWER	5W
LUMEN	400Lm
TEMPERATURE	-20°C~45°C
CCT CHANGE	3000K/4000K/6000K
CRI	Ra>90
OPTICAL	PC diffuser
DRIVER	DC 3V-42V
INPUT VOLTAGE	DC48V
LED CHIP	San'an 2835
PRODUCT SIZE	Ø600*H195
TRACK USED	Ultra-thin track
IP RATING	IP20
MATERIAL	Aluminum cover with painting
FINISH	Wood grain and White/Black and White/White



POWER	8W
LUMEN	640Lm
TEMPERATURE	-20°C~45°C
CCT CHANGE	3000K/4000K/6000K
CRI	Ra>90
OPTICAL	PC diffuser
DRIVER	DC 3V-42V
INPUT VOLTAGE	DC48V
LED CHIP	San'an 2835
PRODUCT SIZE	Ø250*H130mm
TRACK USED	Ultra-thin track
IP RATING	IP20
MATERIAL	Aluminum cover with painting
FINISH	Wood grain and White/Black and White/White



POWER	23W
LUMEN	1840Lm
BEAM ANGLE	15°/24°/36°/60°
TEMPERATURE	-20°C~45°C
CCT CHANGE	3000K/4000K/6000K
CRI	Ra>90
OPTICAL	PC diffuser
DRIVER	DC 3V-42V
INPUT VOLTAGE	DC48V
LED CHIP	San'an 2835
PRODUCT SIZE	Ø330*H100mm
TRACK USED	Ultra-thin track
IP RATING	IP20
MATERIAL	Aluminium cover with painting
FINISH	Black/White/Grey (Any painting color optional)



POWER	30W
LUMEN	2400Lm
TEMPERATURE	-20°C~45°C
CCT CHANGE	3000K/4000K/6000K
CRI	Ra>90
OPTICAL	PMMA tube
DRIVER	DC 3V-42V
INPUT VOLTAGE	DC48V
LED CHIP	San'an 2835
PRODUCT SIZE	L1410*H860mm
TRACK USED	Ultra-thin track
IP RATING	IP20
MATERIAL	Iron tube+PMMA tube
FINISH	Gold



POWER	30W
LUMEN	2400Lm
TEMPERATURE	-20°C~45°C
CCT CHANGE	3000K/4000K/6000K
CRI	Ra>90
OPTICAL	PMMA tube
DRIVER	DC 3V-42V
INPUT VOLTAGE	DC48V
LED CHIP	San'an 2835
PRODUCT SIZE	L1210*H860
TRACK USED	Ultra-thin track
IP RATING	IP20
MATERIAL	Iron tube+PMMA tube
FINISH	Gold



POWER	12W
LUMEN	960Lm
TEMPERATURE	-20°C~45°C
CCT CHANGE	3000K/4000K/6000K
CRI	Ra>90
OPTICAL	PC diffuser
DRIVER	DC 3V-42V
INPUT VOLTAGE	DC48V
LED CHIP	San'an 2835
PRODUCT SIZE	Ø600*H1200mm
LENGTH OF SUSPENSION LINE	1200mm
TRACK USED	Ultra-thin track
IP RATING	IP20
MATERIAL	Aluminum cover with painting
FINISH	Wood grain and White/Black and White/White



POWER	8W
LUMEN	640Lm
TEMPERATURE	-20°C~45°C
CCT CHANGE	3000K/4000K/6000K
CRI	Ra>90
OPTICAL	PC diffuser
DRIVER	DC 3V-42V
INPUT VOLTAGE	DC48V
LED CHIP	San'an 2835
PRODUCT SIZE	Ø450*H1200mm
LENGTH OF SUSPENSION LINE	1200mm
TRACK USED	Ultra-thin track
IP RATING	IP20
MATERIAL	Aluminum cover with painting
FINISH	Wood grain and White/Black and White/White





POWER	5W
LUMEN	400Lm
TEMPERATURE	-20°C~45°C
CCT CHANGE	3000K/4000K/6000K
CRI	Ra>90
OPTICAL	PC diffuser
DRIVER	DC 3V-42V
INPUT VOLTAGE	DC48V
LED CHIP	San'an 2835
PRODUCT SIZE	Ø350*H1200mm
LENGTH OF SUSPENSION LINE	1200mm
TRACK USED	Ultra-thin track
IP RATING	IP20
MATERIAL	Aluminum cover with painting
FINISH	Wood grain and White/Black and White/White

## Modular Circular Spotlight

- High performance, a variety of cover/size/power options
- Can be matched with different optical accessories to meet various lighting needs
- CRI>90, UGR<15, high light extraction rate, good heat dissipation
- Cut out size: Ø55mm / Ø75mm
- Power: 6W / 9W / 12W / 15W

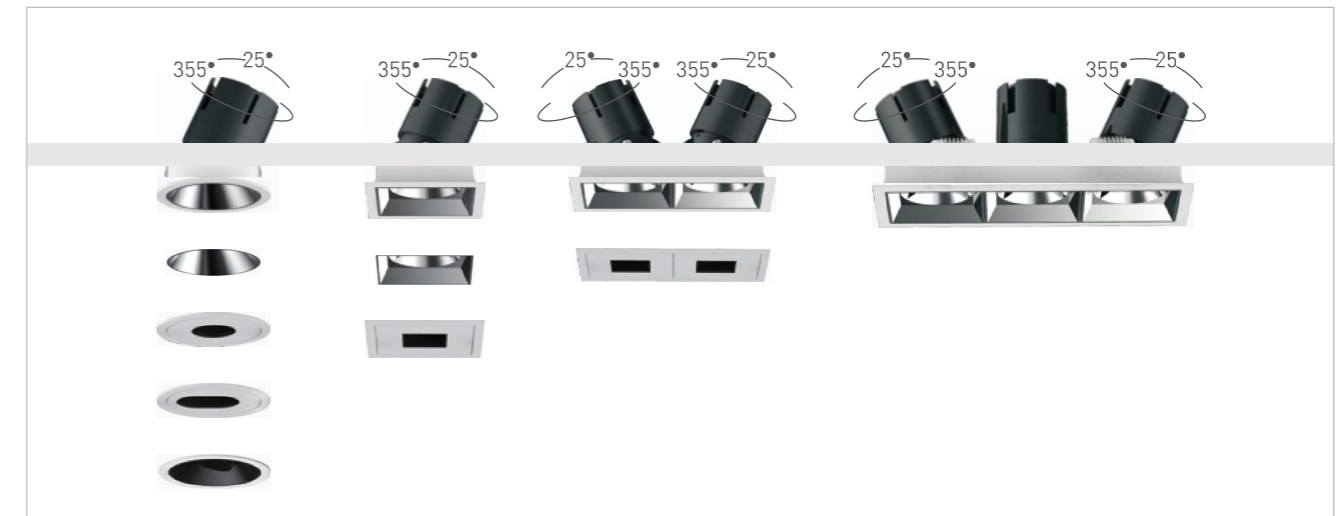

### REFLECTOR COLOUR - ROTATABLE



### REFLECTOR COLOUR - FIXED



### REFLECTOR COLOUR - SQUARE



### REFLECTOR COLOUR - SQUARE



# Modular Circular Spotlight

## DETAILS

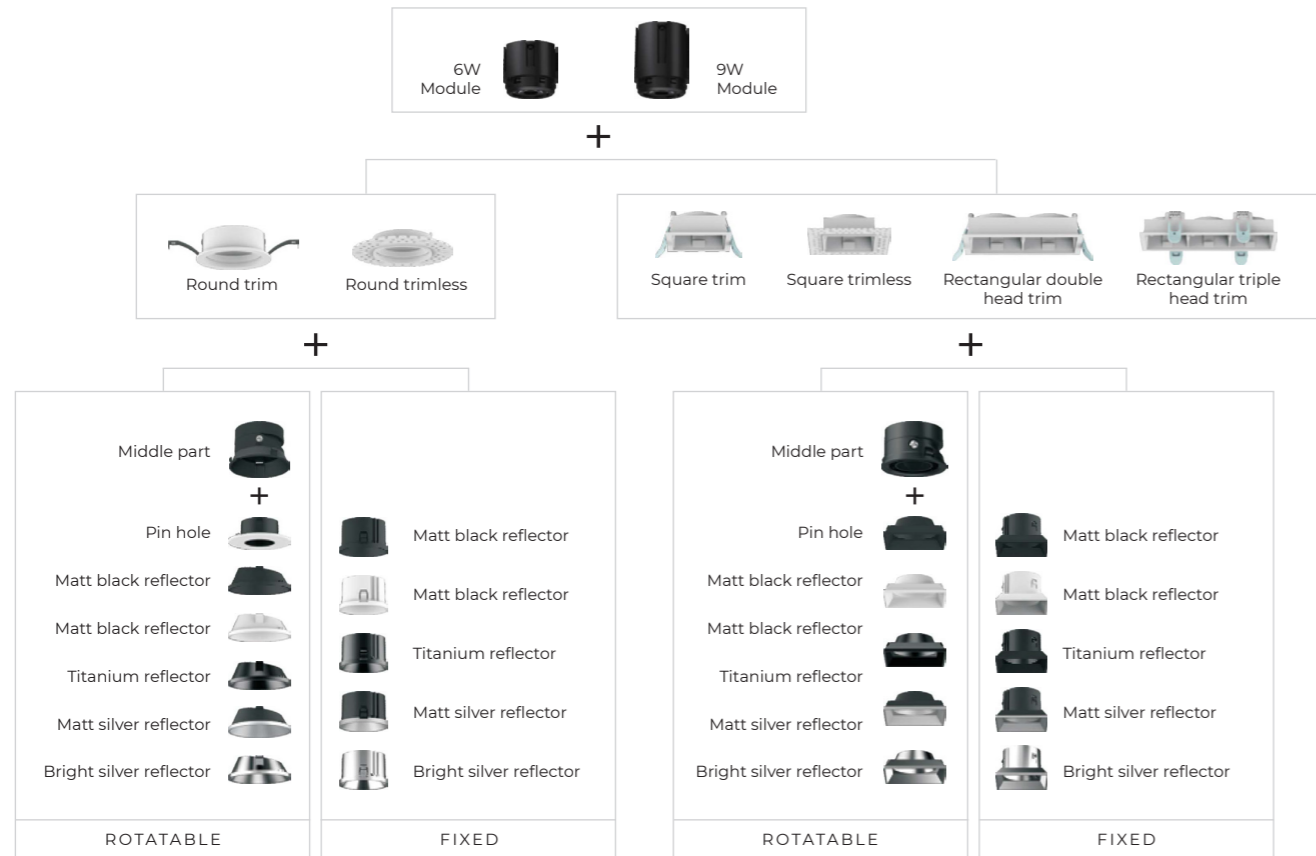

### ACCESSORIES



### OPTIONAL MODULE

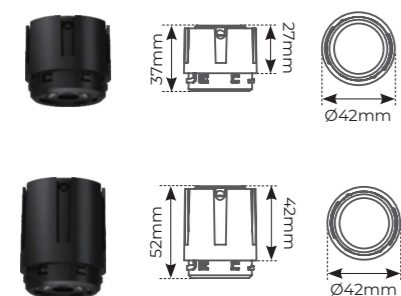

### HOUSING KIT

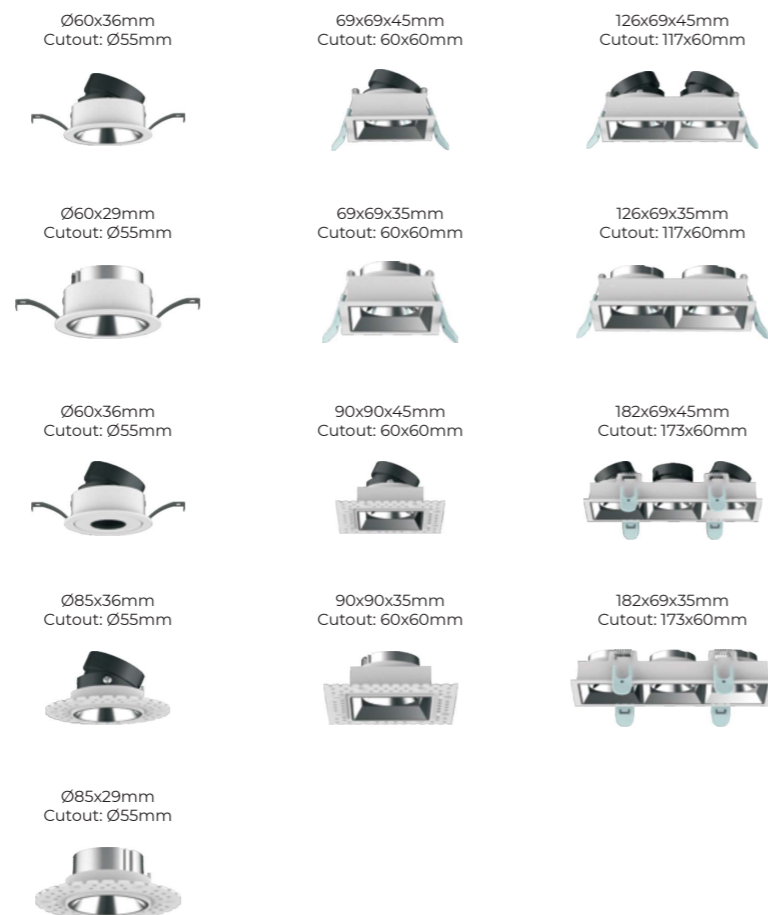

# Modular Linear SpotLight

- Adopt imported COB LED, high CRI, high efficiency, high illumination.
- Self-designed reflector with special optic, precise light distribution and high lumen output, no-glare, soft and tender light.
- Environmental, no UV. nice heat dissipation.
- Easy to install and to adjust.
- Life span up to 50,000 hours
- Various power options for different requirements.
- Applied to shopping mall, hotel, exhibition hall. museum and etc.

# Modular Linear Spotlight



3 LED 5W



6 LED 10W

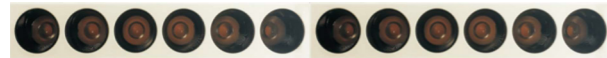

2 x 6 LED 1 x 10W



Detachable light source module

## LIGHT EFFECT



General lighting



Accent Lighting



Wall washing Lighting

## BEAM ANGLE

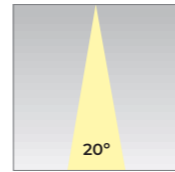

20°

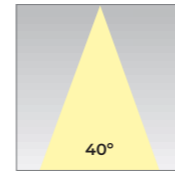

40°

**LB14035001**  
5W

70x32x48mm  
Cutout: 63x25mm

**LB14065001**  
10W

127x32x48mm  
Cutout: 120x25mm

**LB14065001**  
2 x 10W

245x32x48mm  
Cutout: 238x25mm

85x46x48mm  
Cutout: 77x39mm

142x46x48mm  
Cutout: 135x39mm

259x46x48mm  
Cutout: 252x39mm

65x64x48mm  
Cutout: 67x36mm

122x64x48mm  
Cutout: 124x36mm

239x64x48mm  
Cutout: 241x36mm

76x74x48mm  
Cutout: 78x46mm

133x74x48mm  
Cutout: 135x46mm

251x74x48mm  
Cutout: 253x46mm

# Optional Module



Surface Colour Options: **Black**

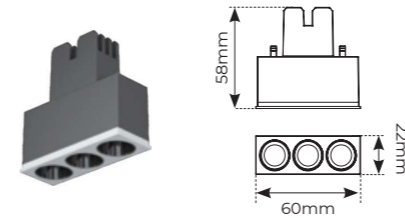

WATTAGE	5W (±10%)
LED CURRENT	DC 500mA
FLUX	300lm
CCT	3000K
CRI	>90

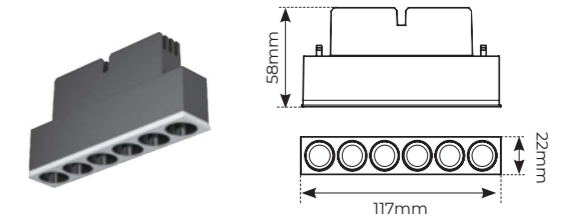
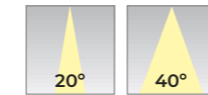

WATTAGE	10W (±10%)
LED CURRENT	DC 500mA
FLUX	700lm
CCT	3000K
CRI	>90

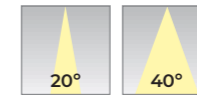

Surface Colour Options: **Black / White**

WATTAGE	5W (±10%)
LED CURRENT	DC 500mA
FLUX	300lm
CCT	3000K
CRI	>90

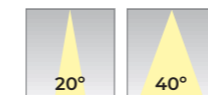

## PRODUCT DRAWING

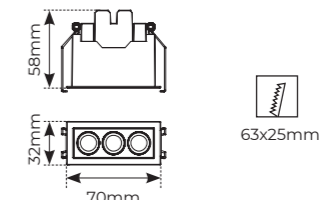

## PRODUCT DRAWING

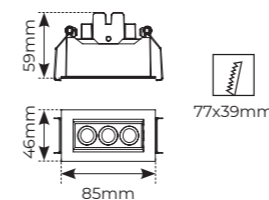

## PRODUCT DRAWING

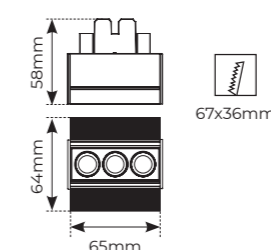

## PRODUCT DRAWING

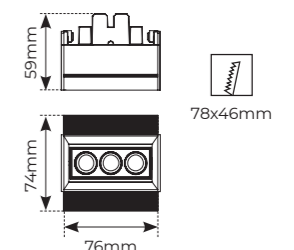

# Modular Linear Spotlight

- 35K Hours
- SMD LED
- <6 SDCM
- <80 CRI
- <90 CRI
- 20°/40° MAX TEMP
- 3000K WARM WHITE
- 4000K NEUTRAL WHITE
- 5000K NEUTRAL WHITE

Surface Colour Options: White & Black

WATTAGE	10W (±10%)
LED CURRENT	DC 500mA
FLUX	700lm
CCT	3000K
CRI	>90

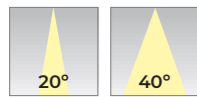

PRODUCT DRAWING

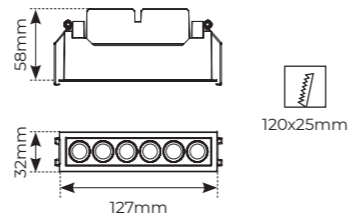

PRODUCT DRAWING

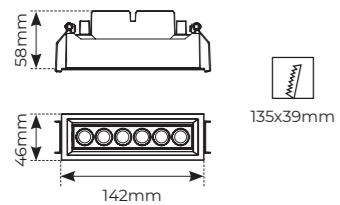

PRODUCT DRAWING

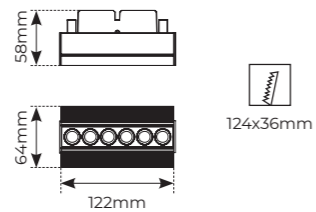

PRODUCT DRAWING

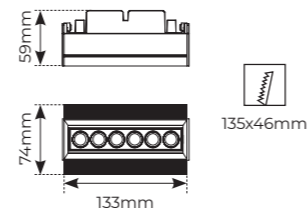

- 35K Hours
- SMD LED
- <6 SDCM
- <80 CRI
- <90 CRI
- 20°/40° MAX TEMP
- 3000K WARM WHITE
- 4000K NEUTRAL WHITE
- 5000K NEUTRAL WHITE

Surface Colour Options: White & Black

WATTAGE	20W (±10%)
LED CURRENT	DC 500mA
FLUX	1350lm
CCT	3000K
CRI	>90

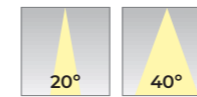

PRODUCT DRAWING

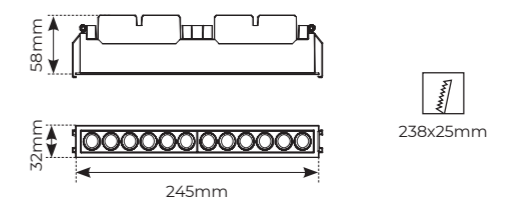

PRODUCT DRAWING

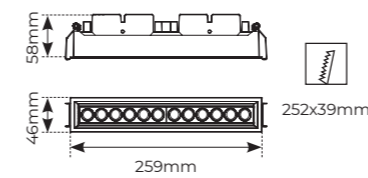

PRODUCT DRAWING

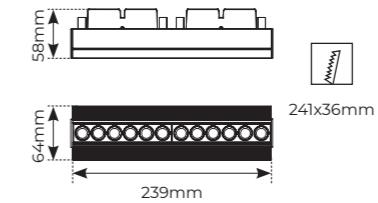

PRODUCT DRAWING

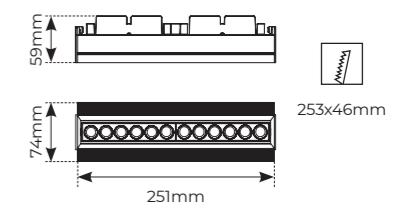

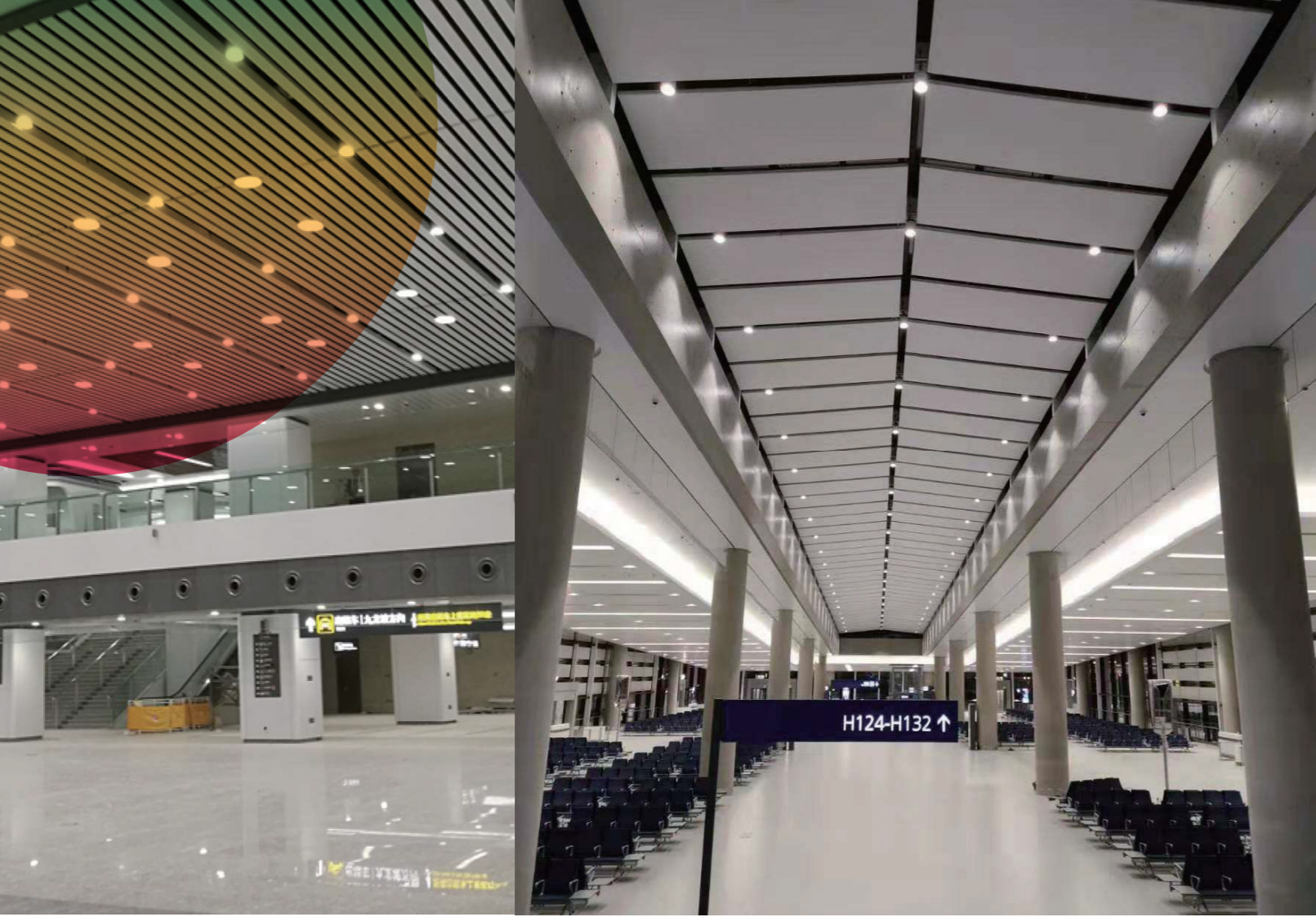

## Surface Mounted DOWNLIGHT

- Human being's normal sight range is straight forward above 30° to under 60° within the scope of the dazzling light, is called glare
- All the CD light of lamps was controlled within the sectional light Angle of 30° >, so glare problem has been controlled well

### PRODUCT DRAWING

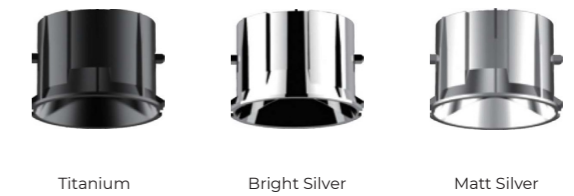
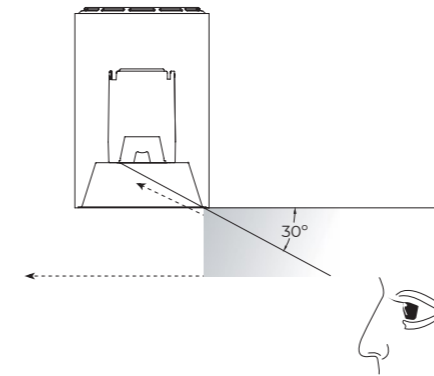

## Surface Mounted Downlight

- Adopt imported LED, high CRI, high efficiency, high illumination.
- Self-designed reflector with special optic, precise light distribution and high lumen output, no-glare, soft and tender light.
- Environmental, no UV, nice heat dissipation.
- Easy to install and to adjust.
- Life span up to 50,000 hours.
- Various power options for different requirements.
- Applied to shopping mall, hotel, exhibition hall, museum and etc.

### CEILING MOUNTED

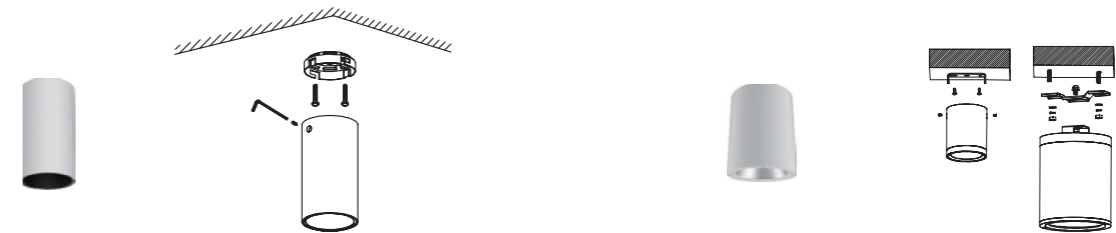

### SCREW POLE PENDANT MODE

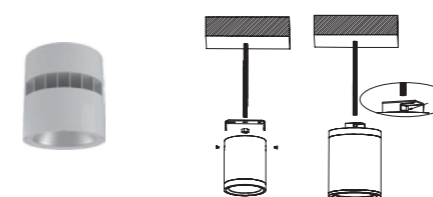

### TRACK MOUNTED

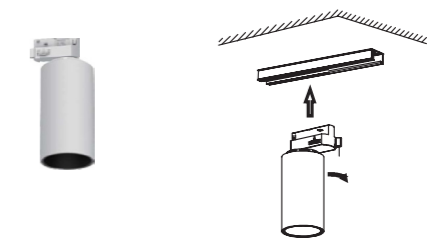

35K Hours  
COB LED  
<3 SDCM  
<80 CRI  
<90 CRI  
-20%/40° MAX TEMP  
2700K WARM WHITE  
3000K WARM WHITE  
4000K NEUTRAL WHITE  
5000K NEUTRAL WHITE

Surface Colour Options: Black / White

WATTAGE	9W (±10%)
LED CURRENT	DC 200mA
FLUX	800lm
CCT	3000K
CRI	>90

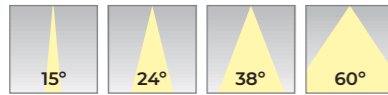

WATTAGE	15W (±10%)
LED CURRENT	DC 350mA
FLUX	1300lm
CCT	3000K
CRI	>90

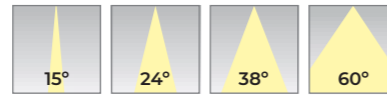

PRODUCT DRAWING

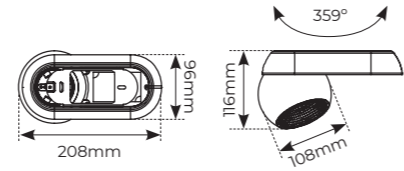

PRODUCT DRAWING

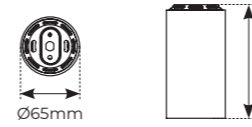

35K Hours  
COB LED  
<3 SDCM  
<95 CRI  
<90 CRI  
-20%/40° MAX TEMP  
2700K WARM WHITE  
3000K WARM WHITE  
4000K NEUTRAL WHITE  
5000K NEUTRAL WHITE

Surface Colour Options: Black / White

WATTAGE	6W (±10%)
LED CURRENT	DC 500mA
FLUX	550lm
CCT	3000K
CRI	>90

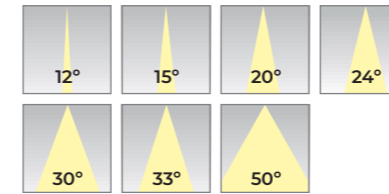

PRODUCT DRAWING

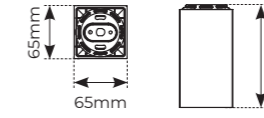

WATTAGE	9W (±10%)
LED CURRENT	DC 200mA
FLUX	800lm
CCT	3000K
CRI	>90

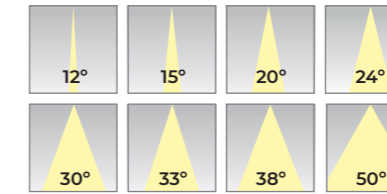

PRODUCT DRAWING

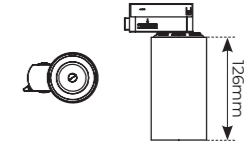

Global Lens Optics:  
CGD-LB1001R-01 Module



Track Connector



2-Phase 3-Phase

Reflector Colour

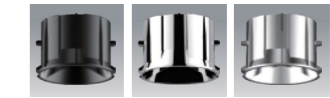

Titanium Bright Silver Matt Silver



PRODUCT DRAWING

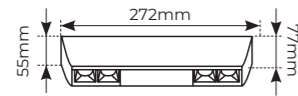

PRODUCT DRAWING

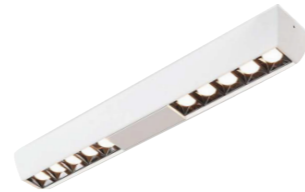
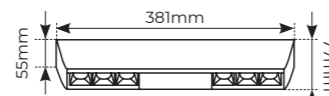

PRODUCT DRAWING

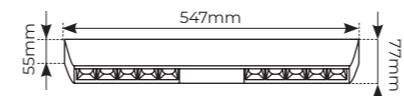

35K Hours  
SMD LED  
<6 SDCM  
<95 CRI  
<90 CRI  
-20%/40° MAX TEMP  
2700K WARM WHITE  
3000K WARM WHITE  
4000K NEUTRAL WHITE  
5000K NEUTRAL WHITE  
5700K NEUTRAL WHITE

Surface Colour Options: Black / White

WATTAGE	20W (±10%)
LED CURRENT	DC 500mA
FLUX	1700lm
CCT	3000K
CRI	>90

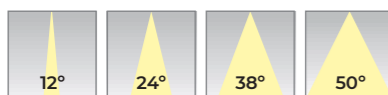

WATTAGE	30W (±10%)
LED CURRENT	DC 2x350mA
FLUX	2550lm
CCT	3000K
CRI	>90

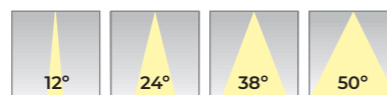

WATTAGE	40W (±10%)
LED CURRENT	DC 2x500mA
FLUX	3600lm
CCT	3000K
CRI	>90



35K Hours  
COB LED  
<3 SDCM  
<95 CRI  
<90 CRI  
-20%/40° MAX TEMP  
2700K WARM WHITE  
3000K WARM WHITE  
4000K NEUTRAL WHITE  
5000K NEUTRAL WHITE

Surface Colour Options: White

WATTAGE	75W (±10%)
LED CURRENT	DC 1900mA
FLUX	3700lm
CCT	3000K
CRI	>90

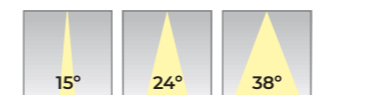

WATTAGE	100W (±10%)
LED CURRENT	DC 2500mA
FLUX	5250lm
CCT	3000K
CRI	>90

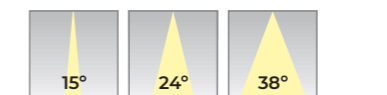

Accessories



Protection Net

Reflector



PRODUCT DRAWING

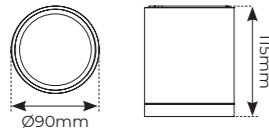

PRODUCT DRAWING

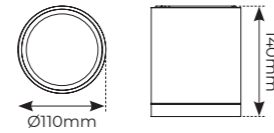

PRODUCT DRAWING

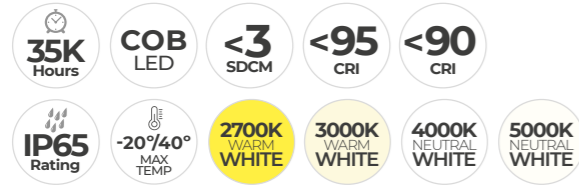
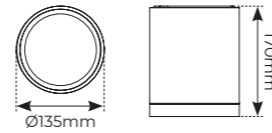

Surface Colour Options: **White**

WATTAGE	9W (±10%)
LED CURRENT	DC 200mA
FLUX	800lm
CCT	3000K
CRI	>90

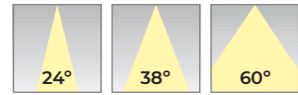

WATTAGE	15W (±10%)
LED CURRENT	DC 350mA
FLUX	1400lm
CCT	3000K
CRI	>90

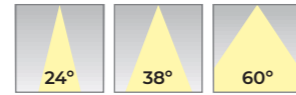

WATTAGE	28W (±10%)
LED CURRENT	DC 700mA
FLUX	2500lm
CCT	3000K
CRI	>90

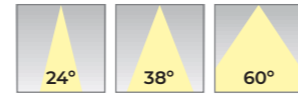

WATTAGE	12W (±10%)
LED CURRENT	DC 300mA
FLUX	110lm
CCT	3000K
CRI	>90

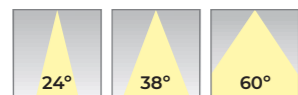

WATTAGE	24W (±10%)
LED CURRENT	DC 600mA
FLUX	2300lm
CCT	3000K
CRI	>90

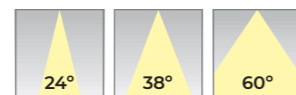

WATTAGE	32W (±10%)
LED CURRENT	DC 800mA
FLUX	2900lm
CCT	3000K
CRI	>90

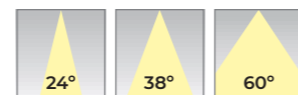

WATTAGE	15W (±10%)
LED CURRENT	DC 350mA
FLUX	1350lm
CCT	3000K
CRI	>90

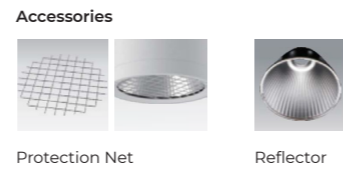
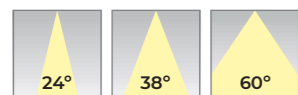

PRODUCT DRAWING

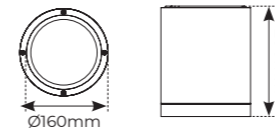

PRODUCT DRAWING

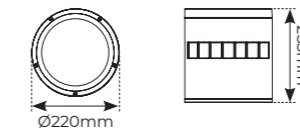

PRODUCT DRAWING

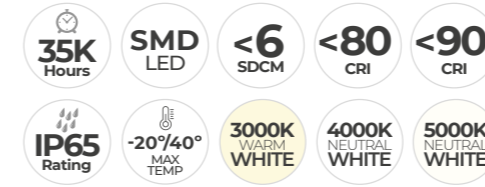
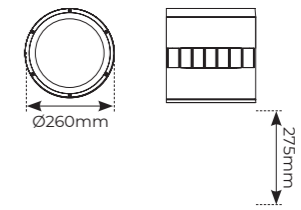

Surface Colour Options: **White**

WATTAGE	35W (±10%)
LED CURRENT	DC 660mA
FLUX	800lm
CCT	3700K
CRI	>90

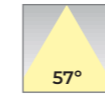

WATTAGE	75W (±10%)
LED CURRENT	DC 1400mA
FLUX	8250lm
CCT	3000K
CRI	>90

WATTAGE	120W (±10%)
LED CURRENT	DC 2300mA
FLUX	14000lm
CCT	3000K
CRI	>90



WATTAGE	50W (±10%)
LED CURRENT	DC 940mA
FLUX	5250lm
CCT	3000K
CRI	>90

WATTAGE	100W (±10%)
LED CURRENT	DC 1900mA
FLUX	11000lm
CCT	3000K
CRI	>90

WATTAGE	150W (±10%)
LED CURRENT	DC 2800mA
FLUX	16500lm
CCT	3000K
CRI	>90

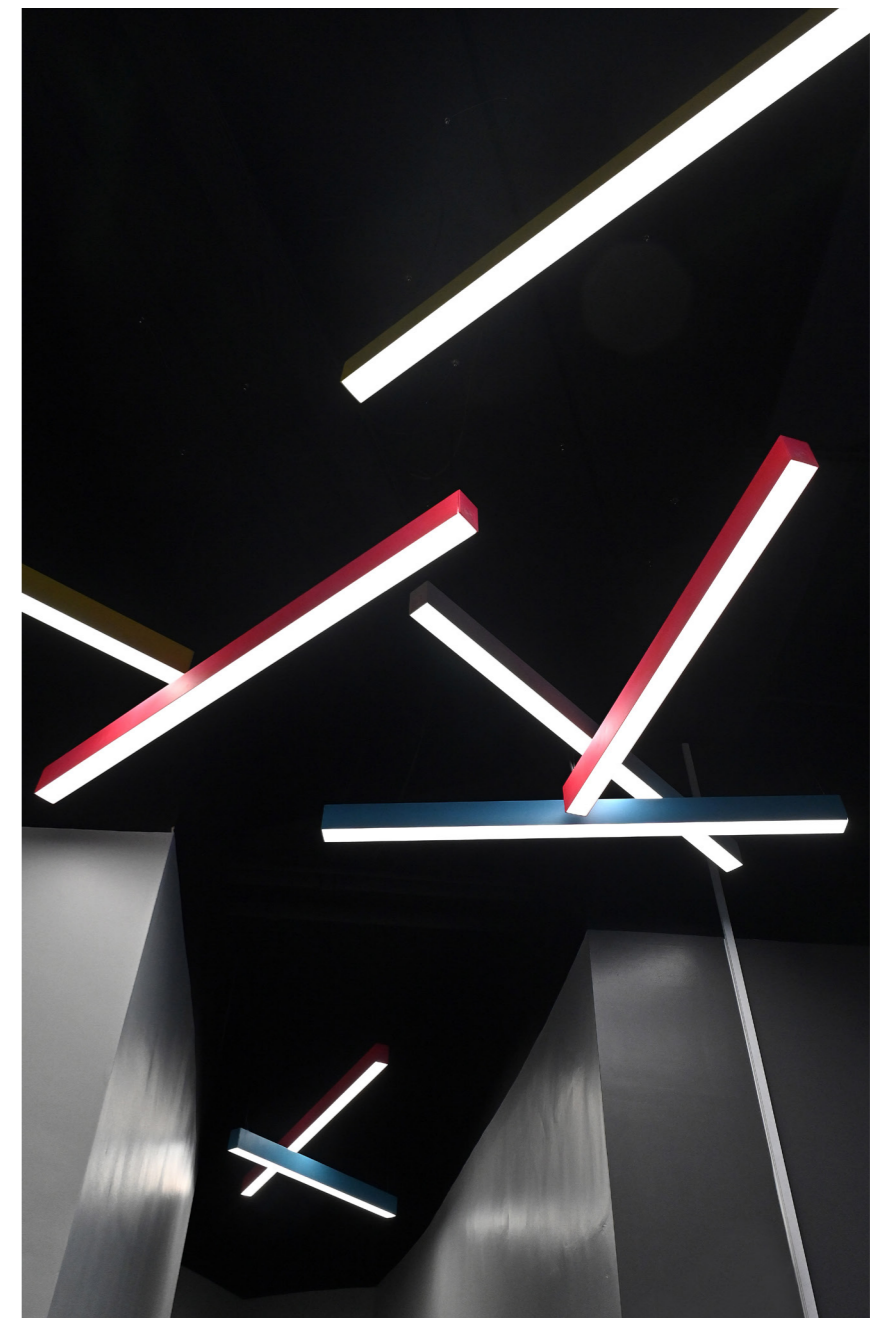
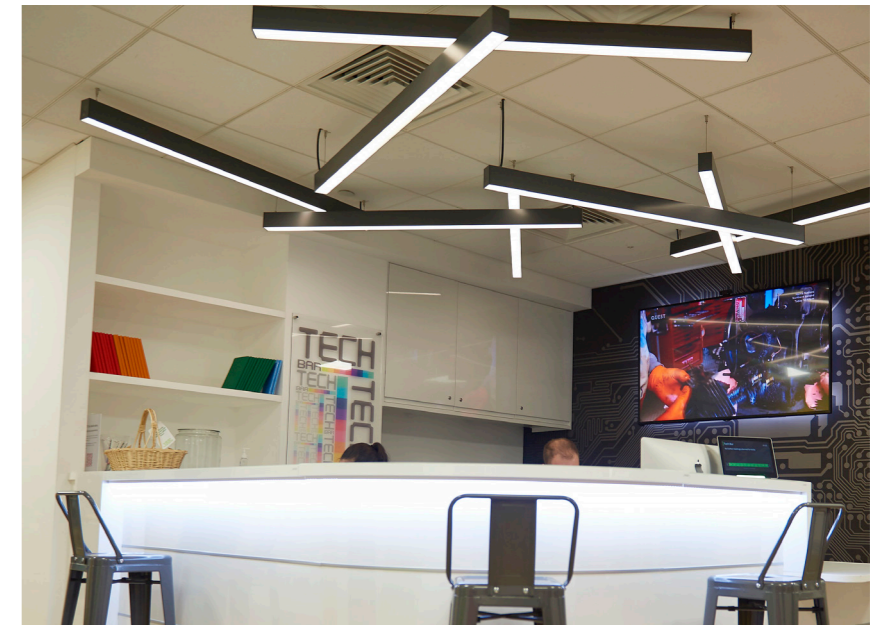



**UK:****HEAD OFFICE:**

Email: [info@luceco.com](mailto:info@luceco.com)

Luceco plc, Caparo House  
103 Baker Street, London  
England, W1U 6LN

**DISTRIBUTION CENTRE:**

Tel: +44 (0) 1952 238 100  
Email: [uk\\_sales@luceco.com](mailto:uk_sales@luceco.com)

Luceco plc  
Luceco Distribution Centre  
Stafford Park 1, Telford  
Shropshire, England, TF3 3BD

**IRELAND:**

Email: [sales@luceco.ie](mailto:sales@luceco.ie)

**FRANCE:**

Email: [fr\\_sales@luceco.com](mailto:fr_sales@luceco.com)

**ITALY:**

Email: [it\\_sales@luceco.com](mailto:it_sales@luceco.com)

**SPAIN:**

Tel: +34 93 829 55 75  
Email: [es\\_sales@luceco.com](mailto:es_sales@luceco.com)

Luceco Southern Europe S.L.  
C/ Bobinadora 1-5  
08302 Mataró  
Barcelona, Spain

**MIDDLE EAST & AFRICA:**

Tel: +971 4 609 1867  
Email: [mea\\_sales@luceco.com](mailto:mea_sales@luceco.com)

Luceco Middle East FZCO  
Bldg. 5EB, Office 342  
PO Box 371128, DAFZA  
Dubai, UAE

**ASIA PACIFIC:****JIAXING:**

Tel: +86 (0) 573 8357 0200  
Email: [asia\\_sales@luceco.com](mailto:asia_sales@luceco.com)

No 1438, Jiachuang Road  
Xiuzhou Industrial Park, Jiaxing  
Zhejiang, China, P.C. 314031

**HONG KONG:**

Email: [hk\\_sales@luceco.com](mailto:hk_sales@luceco.com)

**UNITED STATES:**

Email: [us\\_sales@luceco.com](mailto:us_sales@luceco.com)

**MEXICO & LATIN AMERICA:**

Tel: +52 (81) 5000 9437  
Email: [ventas@luceco.com](mailto:ventas@luceco.com)

Luceco México  
AV Lázaro Cárdenas #318 int 201  
Col Real San Agustín  
San Pedro Garza García  
N.L. Mexico CP 66278

**TECHNICAL SUPPORT:**

Tel: 01952 238 128  
Email: [technical@luceco.com](mailto:technical@luceco.com)

Lines open Monday to Friday  
8.30am to 5pm, with answer phone  
service outside these hours.

**LUCECO**  
G R O U P

**LUCECO**  
LIGHTING

**DW**  
Windsor

**PULSAR**

**Kingfisher**  
Lighting

**urbancontrol**

**DECOSCAPE**