



EDDINS
INSPIRED LIGHTING



At **Eddins**, we believe that lighting is beyond functionality and we work to provide an inspirational range of unique products designed to meet the needs of Architects / Designers to enhance the concept and interior ambience.

We sincerely hope our products and ability will transform our Client's inspiration and imaginations to reality... We continuously strive to innovate and upgrade our existing range and also introduce innovative energy efficient products to keep in pace with the global aspiration.





We design and manufacture in conjunction with our technical expertise and experience to provide an extensive range of quality products of both standard and

BESPOKE

product designs suitable for high quality contract interiors. We deploy stringent quality management system which starts from initial design to the final product.

Our Design department would be pleased to assist your project product designs, CAD drawings, 3D visuals, lighting design calculations from the initial stages. Our highly experienced lighting consultants in International Hospitality market would be delighted to meet and discuss in detail.

Design and manufacture of Bespoke light fittings has become a significant part of our business, we use diverse range of materials like Glass, Poly-Resin, Crystals, Natural Materials as per the project needs, specification and design aspects.





Outstanding Bespoke Lighting
for the International Hospitality Market

Table Lamps



Floor Lamps

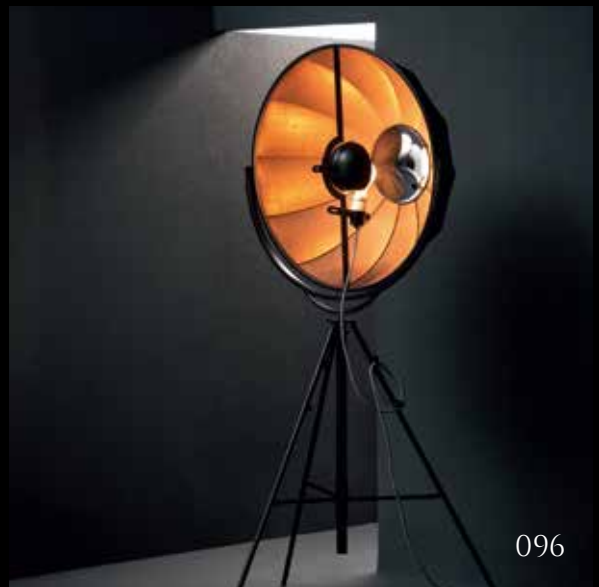

Wall Lights



Chandeliers

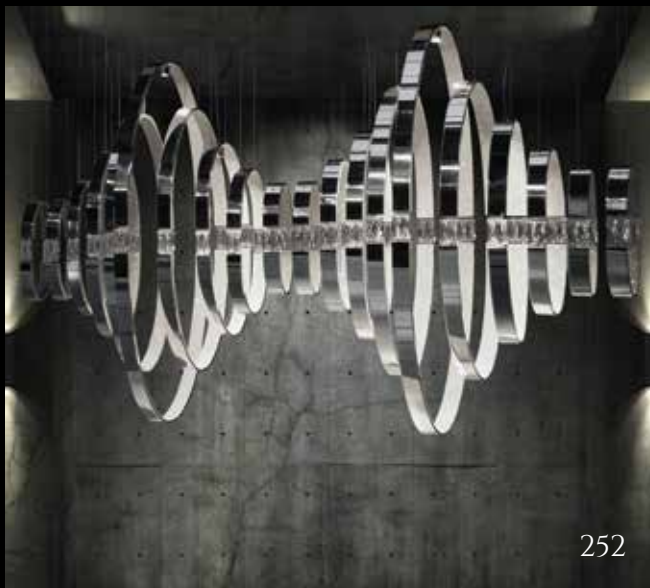
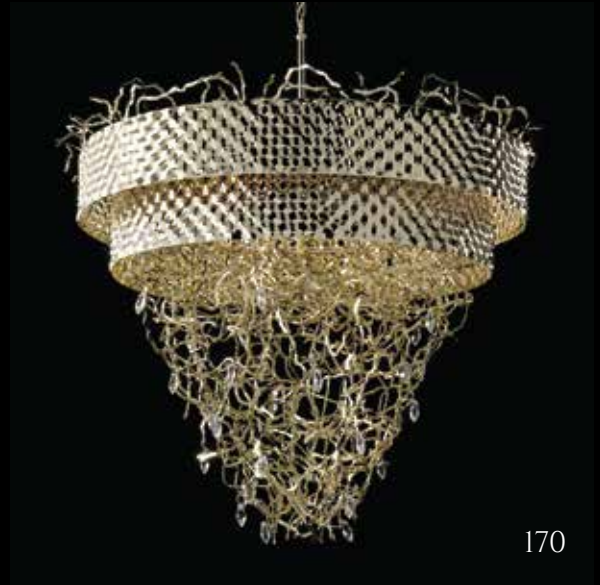



ED 400474

Finish: Satin nickel metal work with
beige fabric shade

LUNA

Model	Width (mm)	Height (mm)	Lamp
ED 400474	460	560	E 27 7.5 W LED WW
ED 400475	600	1680	E 27 7.5 W LED WW

FO Please add suffix for alternate metal finish and shade options - Refer page no. 333-334

Finish Option



ED 400475

Finish: Satin nickel metal work with
beige fabric shade



ED 400476
Finish: Metallic gold /
lead finish



ED 400477
Finish: Metallic gold / lead finish

LUNA

ED 400478

Finish: Metallic gold / lead finish

Model	Width (mm)	Height (mm)	Proj. (mm)	Lamp
ED 400476	190	490	-	E 14 2.3 W LED WW
ED 400477	220	250	230	E 14 2.3 W LED WW
ED 400478	280	1660	-	E 14 2.3 W LED WW



Please add suffix for alternate metal finish and shade options - Refer page no. 333-334

SLADE

SLADE

Finish: Mahogany wood with polished chrome metal work and beige fabric shade



ED 400558



ED 400588



Model	Width (mm)	Height (mm)	Lamp
ED 400558	400	1700	E 27 7.5 W LED WW
ED 400588	320	580	E 27 7.5 W LED WW

FO Please add suffix for alternate metal / wood finish and shade options - Refer page no. 333-334
Finish Option

SLADE

Finish: Polished chrome metal work
with white fabric shade



ED 400559



ED 400589

Model	Width (mm)	Height (mm)	Proj. (mm)	Lamp
ED 400559	200	770	240	E 27 7.5 W LED WW
ED 400589	400	770	-	E 27 7.5 W LED WW



ED 400560

SLADE

Finish: Polished chrome metal work with
beige fabric shade

Model	Width (mm)	Height (mm)	Lamp
ED 400560	420	1660	E 27 7.5 W LED WW
ED 400590	380	E 27 7.5 W LED WW	



ED 400590

SLADE

Model	Width (mm)	Height (mm)	Lamp
ED 400561	380	1690	E 27 7.5 W LED WW
ED 400591	470	620	2 x E 14 2.3 W LED WW



LUNA



ED 400479



ED 400480

LUNA

Finish: Matt white or black



ED 400481 / B / C
Finish: Matt white or black

LUNA

Model	Width (mm)	Height (mm)	Lamp
ED 400479	600	1800	3 x E 27 7.5 W LED WW
ED 400480	450	730	2 x E 27 7.5 W LED WW
ED 400481	450	360	2 x E 27 7.5 W LED WW
ED 400481 B	600	490	3 x E 27 7.5 W LED WW
ED 400481 C	900	720	4 x E 27 7.5 W LED WW

ED 400482

LUNA

Finish: Polished chrome metal work with
beige fabric shade

Model	Width (mm)	Height (mm)	Lamp
ED 400482	500	1890	Built in LED 25W
ED 400482 B	450	990	Built in LED 12.5W



ED 400482 B





LUNA

Finish: Polished nickel metal work
with black fabric shade



ED 400486



ED 400487

Model	Width (mm)	Height (mm)	Proj. (mm)	Lamp
ED 400486	250	370	200	E 27 7.5 W LED WW
ED 400487	450	770	-	E 27 7.5 W LED WW
ED 400488	500	1700	-	E 27 7.5 W LED WW



Please add suffix for alternate metal finish and shade options - Refer page no. 333-334

LUNA

Finish: Polished nickel metal work
with black fabric shade

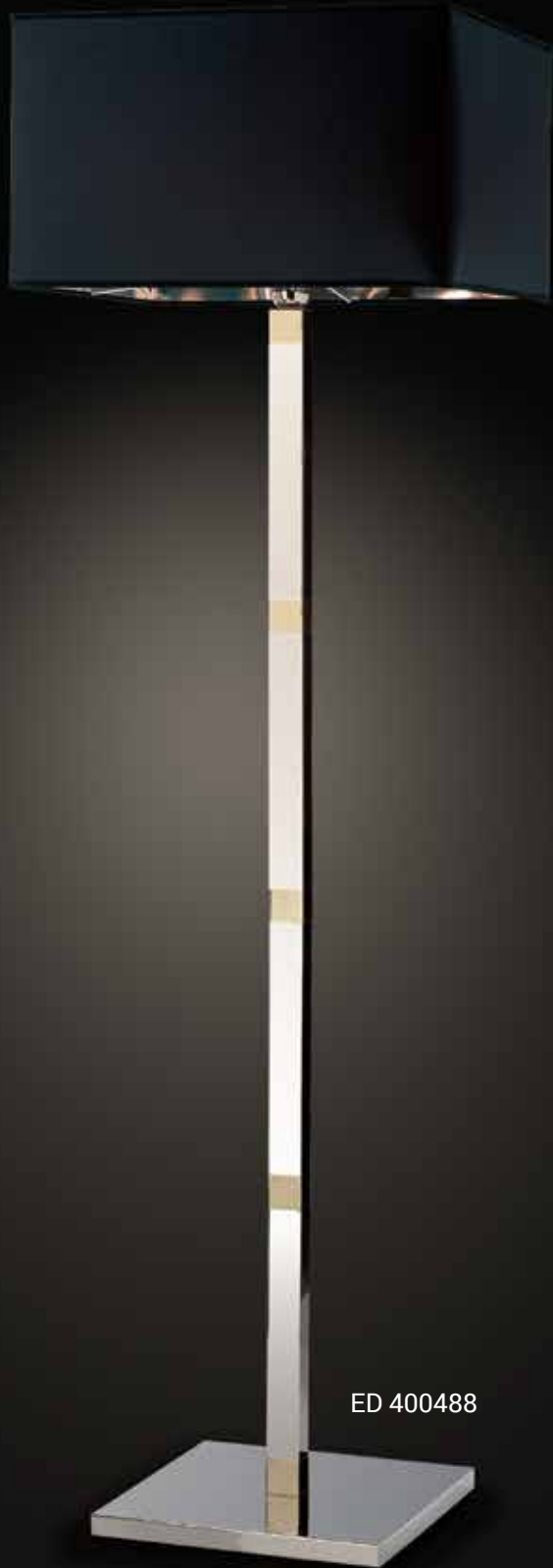

ED 400488

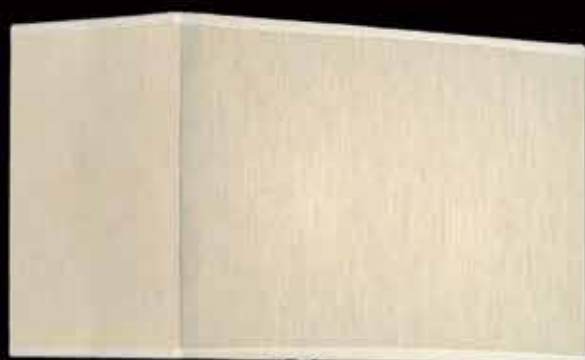

SLADE

Model	Width (mm)	Height (mm)	Lamp
ED 400609	350	600	E 27 7.5 W LED WW
ED 400774	500	1630	E 27 7.5 W LED WW



ED 400774
Finish: Polished chrome with
beige fabric shade

ED 400609
Finish: Polished chrome
with beige fabric shade







ED 400651
Finish: Polished chrome with champagne fabric shade

SLADE

Model	Width (mm)	Height (mm)	Proj. (mm)	Lamp
ED 400651	250	400	320	E 27 7.5 W LED WW
ED 400816	350	650	390	E 27 7.5 W LED WW
ED 400816B	250	490	290	E 27 7.5 W LED WW
ED 400775	450	1760	500	E 27 7.5 W LED WW



ED 400816
Finish: Polished chrome with champagne fabric shade



ED 400816B
Finish: Polished chrome with champagne fabric shade

FO Please add suffix for alternate metal finish and shade options - Refer page no. 333-334
Finish Option



ED 400775

Finish: Polished chrome with
champagne fabric shade

Model	Width (mm)	Height (mm)	Lamp
ED 400612	460	790	E 27 7.5 W LED WW
ED 400776	500	1720	E 27 7.5 W LED WW

SLADE



ED 400776
Finish: Polished chrome
with dark ebony wood and
pleated beige fabric shade



ED 400612
Finish: Polished chrome
with dark ebony wood and
pleated beige fabric shade



SLADE

Model	Width (mm)	Height (mm)	Proj. (mm)	Lamp
ED 400653	350	1120	220	E 27 7.5 W LED WW
ED 400660	210	290	170	E 27 7.5 W LED WW
ED 400613	360	540	-	E 27 7.5 W LED WW
ED 400778	500	1680	-	E 27 7.5 W LED WW



ED 400653

Finish: Polished chrome with
dark brown fabric shade

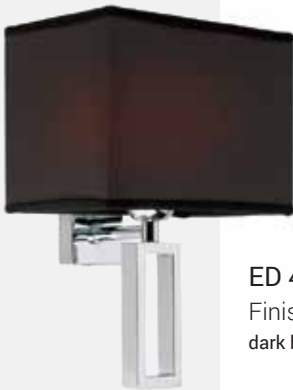

ED 400660

Finish: Polished chrome with
dark brown fabric shade



ED 400613

Finish: Polished chrome with
dark brown fabric shade



Please add suffix for alternate metal finish and shade options - Refer page no. 333-334



ED 400778

Finish: Polished chrome with
dark brown fabric shade

SLADE



ED 400654

Finish: Polished chrome with dark brown fabric shade

Model	Width (mm)	Height (mm)	Proj. (mm)	Lamp
ED 400654	220	280	170	E 27 7.5 W LED WW
ED 400615	240	500	-	E 27 7.5 W LED WW
ED 400780	350	1750	-	E 27 7.5 W LED WW



ED 400615

Finish: Polished chrome with dark brown fabric shade



Please add suffix for alternate metal finish and shade options - Refer page no. 333-334



ED 400780
Finish: Polished chrome
with dark brown fabric shade



SLADE

Model	Width (mm)	Height (mm)	Proj. (mm)	Lamp
ED 400657	370	250	180	2 x E 14 2.3 W LED WW
ED 400887	150	230	180	E 14 2.3 W LED WW
ED 400616	300	690	-	E 27 7.5 W LED WW
ED 400781	400	1620	-	E 27 7.5 W LED WW

ED 400657

Finish: Polished nickel with pleated beige fabric shade



ED 400887

Finish: Polished nickel with pleated beige fabric shade



ED 400616

Finish: Polished nickel with pleated beige fabric shade



Please add suffix for alternate metal finish and shade options - Refer page no. 333-334



ED 400781

Finish: Polished nickel with pleated
beige fabric shade

SLADE



ED 400658
Finish: Polished chrome with
off-white fabric shade

Model	Width (mm)	Height (mm)	Proj. (mm)	Lamp
ED 400658	260	220	320	E 27 7.5 W LED WW
ED 400663	300	320	370	E 27 7.5 W LED WW + LED 1.4W Warm White
ED 400617	300	610	300	E 27 7.5 W LED WW
ED 400782	410	1700	400	E 27 7.5 W LED WW



ED 400663
Finish: Polished chrome with
off-white fabric shade



ED 400617
Finish: Polished chrome with
off-white fabric shade



Please add suffix for alternate metal finish and shade options - Refer page no. 333-334



ED 400782

Finish: Polished chrome with
off-white fabric shade





P 043



P 051



P 060

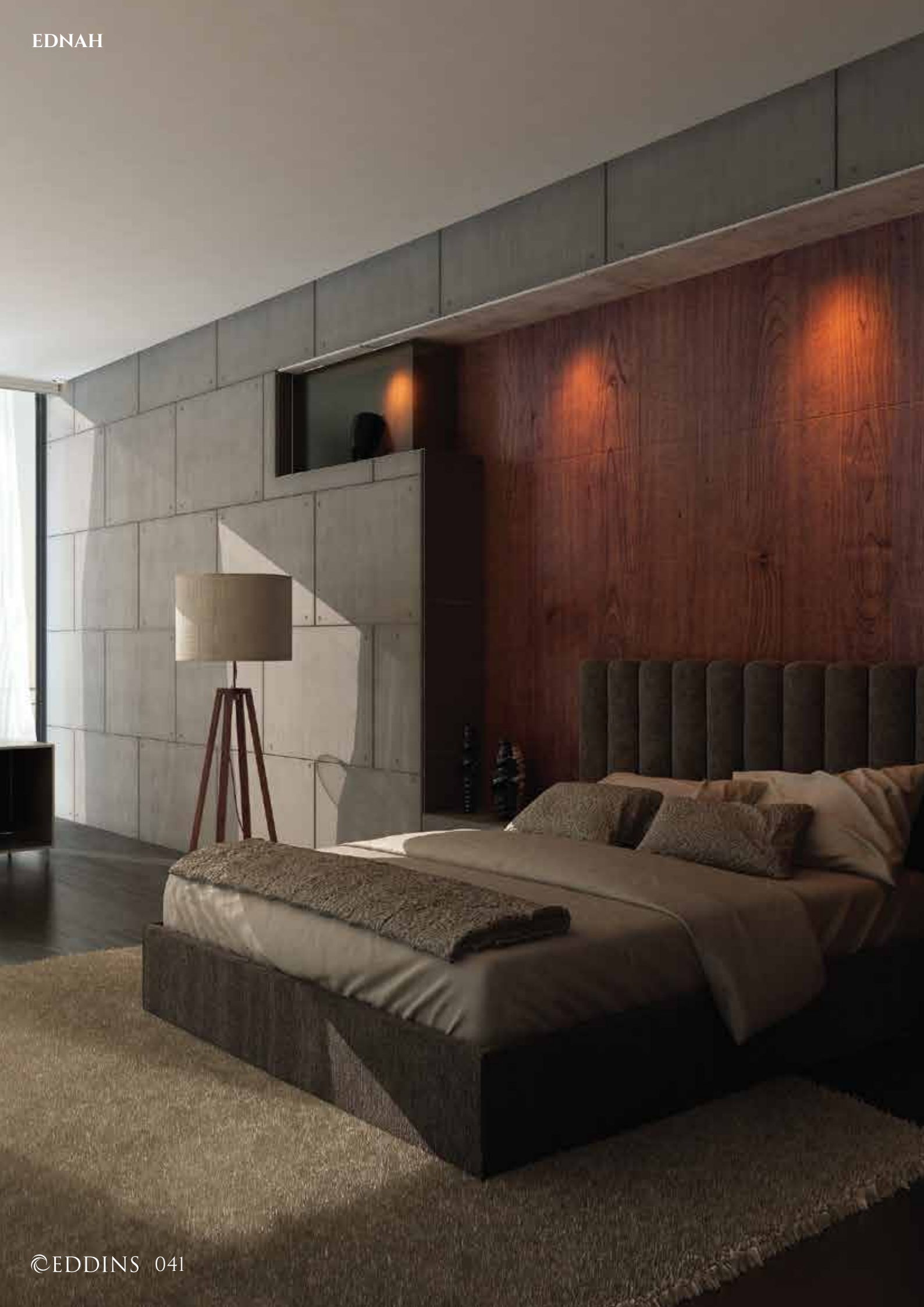

EDNAH

Model	Width (mm)	Height (mm)	Lamp
ED 400788	700	1750	E 27 7.5 W LED WW
ED 400791	400	1810	E 27 7.5 W LED WW



ED 400788

Finish: Polished chrome metal work and dark brown base with pleated fabric shade



ED 400791

Finish: Polished chrome metal work and off-white base with pleated fabric shade

EDNAH



EDNAH

EDNAH

Model	Width (mm)	Height (mm)	Lamp
ED 400489	500	1600	E 27 7.5 W LED WW
ED 400492	500	800	E 27 7.5 W LED WW



ED 400492

Finish: Metallic finish table lamp with metal woven shade (steel or brass finish)



ED 400489

Finish: Metallic finish floor lamp with metal woven shade (steel or brass finish)

FO Please add suffix for alternate metal finish and shade options - Refer page no. 333-334

Finish Option

EDNAH



ED 400897

Finish: Polished chrome with beige fabric shade



ED 400655

Finish: Polished chrome with beige fabric shade



ED 400661

Finish: Polished chrome with beige fabric shade

Model	Width (mm)	Height (mm)	Proj. (mm)	Lamp
ED 400897	250	580	130	2 x E 14 2.3 W LED WW
ED 400655	250	280	150	E 14 2.3 W LED WW
ED 400661	400	260	170	2 x E 14 2.3 W LED WW



Please add suffix for alternate metal finish and shade options - Refer page no. 333-334



ED 400652

Finish: Polished chrome with
pleated beige fabric shade



ED 400656

Finish: Polished chrome with
pleated beige fabric shade

EDNAH

Model	Width (mm)	Height (mm)	Proj. (mm)	Lamp
ED 400900	350	1130	240	E 27 7.5 W LED WW
ED 400652	210	310	170	E 27 7.5 W LED WW
ED 400656	320	340	190	2 x E 27 7.5 W LED WW

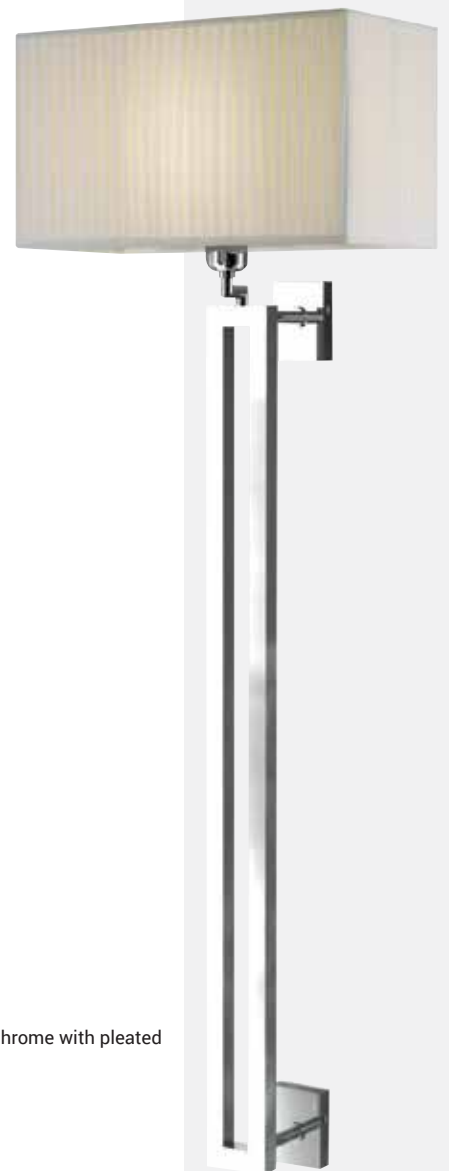

ED 400900

Finish: Polished chrome with pleated
beige fabric shade



Please add suffix for alternate metal finish and shade options - Refer page no. 333-334



ED 400662

Finish: Polished chrome finish with
off-white pleated fabric shade

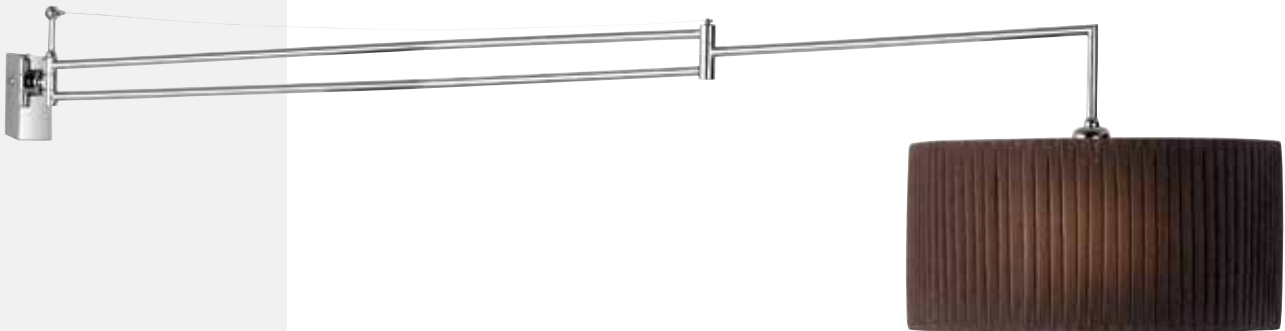

ED 400664

Finish: Polished chrome finish with
dark brown pleated fabric shade

EDNAH

Model	Width (mm)	Height (mm)	Proj. (mm)	Lamp
ED 400662	400	520	900	E 27 7.5 W LED WW
ED 400664	400	410	1750	E 27 7.5 W LED WW

FO Please add suffix for alternate metal finish and shade options - Refer page no. 333-334
Finish Option

EDNAH

Model	Width (mm)	Height (mm)	Proj. (mm)	Lamp
ED 400859	230	530	360	E 14 2.3 W LED WW
ED 400686	510	260	260	E 14 2.3 W LED WW



ED 400859

Finish: Polished nickel with pleated coffee brown fabric shade



ED 400686

Finish: Polished nickel with pleated coffee brown fabric shade



Please add suffix for alternate metal finish and shade options - Refer page no. 333-334

Finish Option



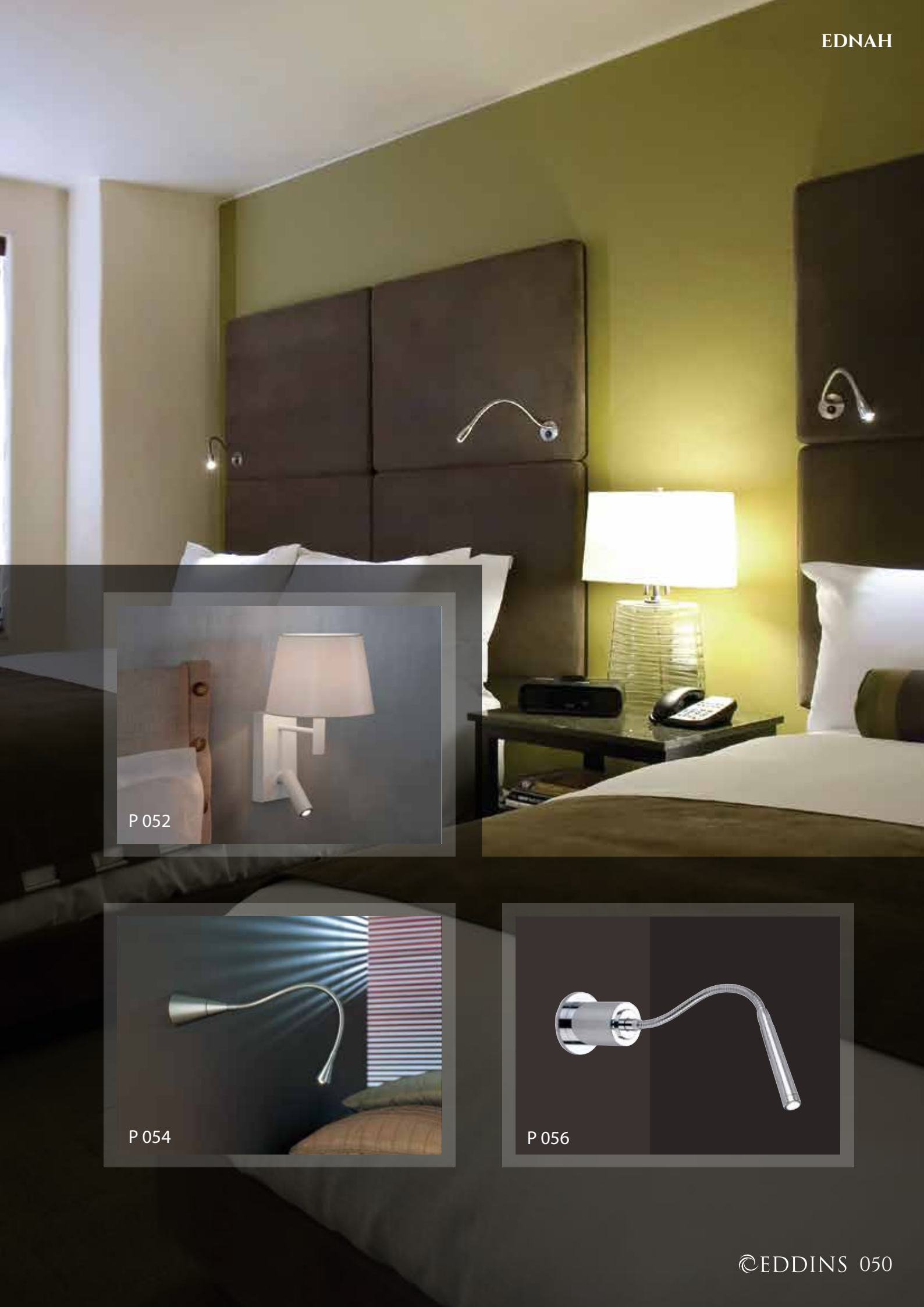

P 052

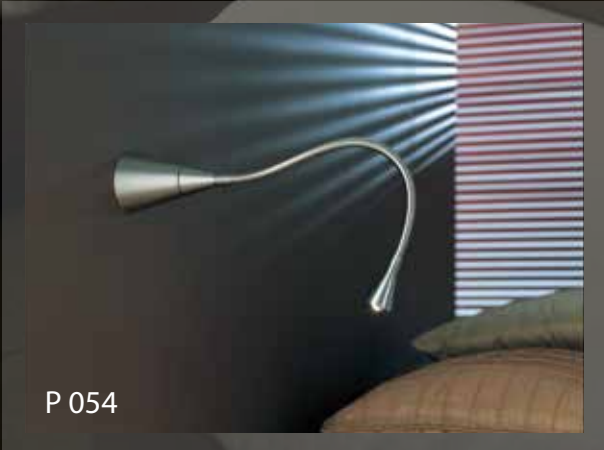

P 054



P 056



ED 400493



ED 400508

EDNAH

Finish: Satin nickel with shade in
white / beige / stone grey / black

Model	Width (mm)	Height (mm)	Proj. (mm)	Lamp
ED 400493	190	660	210	E 14 2.3 W LED WW + 2W 100 3100 K
ED 400508	190	380	310	E 14 2.3 W LED WW

FO Please add suffix for alternate metal finish and shade options - Refer page no. 333-334



ED 400509

Finish: Satin nickel / white metal work
with shade in White / beige / stone grey / black



ED 400510

Finish: Satin nickel / white metal work

EDNAH

Model	Width (mm)	Height (mm)	Proj. (mm)	Lamp
ED 400509	230	390	270	E 14 2.3 W LED WW + 1x 2W 100 3100 K
ED 400510	300	120	500	LED 7.5 W 534 Lumen 3100 K + LED 2 W 100 3100 K



ED 400518



ED 400519

EDNAH

Finish: Satin nickel / chrome / white / black metal work

Model	Width (mm)	Height (mm)	Proj. (mm)	Lamp
ED 400518	55	100	150	LED 1 x 2W 100 3100 K
ED 400519	55	100	520	LED 1 x 2 W 100 3100K

FO Please add suffix for alternate metal finish - Refer page no. 333
Finish Option



ED 400520



ED 400521

EDNAH

Finish: Satin nickel / chrome / white / black metal work

Model	Width (mm)	Height (mm)	Proj. (mm)	Lamp
ED 400520	80	-	530	LED 2 W 100 3100K
ED 400521	100	50	570	LED 4.5 W 300

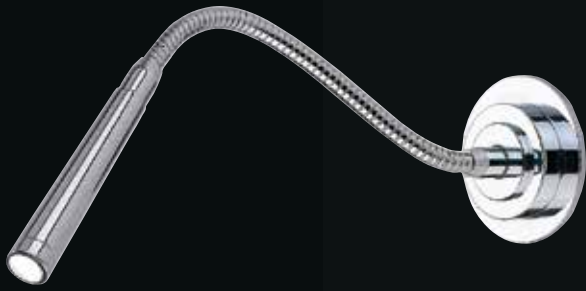

ED 400679

Finish: Polished chrome / Satin nickel metal work

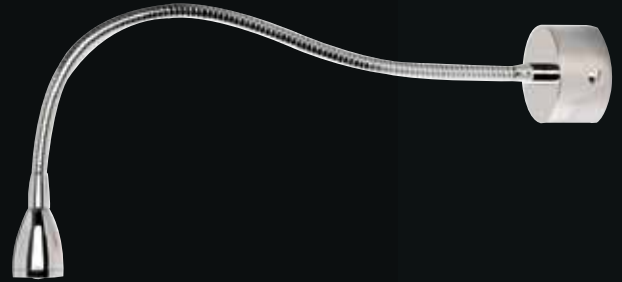

ED 400678

Finish: Polished chrome / Satin nickel metal work

EDNAH

Model	Width (mm)	Proj. (mm)	Lamp
ED 400678	60	520	LED 1.4W
ED 400679	60	480	LED 1.4W

FO Please add suffix for alternate metal finish - Refer page no. 333

Finish Option

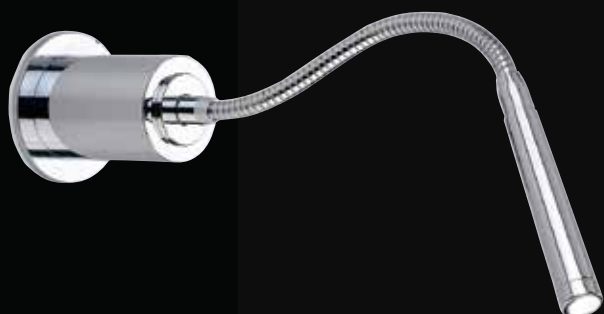

ED 400682

Finish: Polished chrome / Satin nickel metal work



ED 400681

Finish: Polished chrome / Satin nickel metal work

EDNAH

Model	Width (mm)	Proj. (mm)	Lamp
ED 400681	60	520	LED 1.4W
ED 400682	60	360	LED 1.4W



ED 400680

Finish: Polished chrome / Satin nickel metal work



ED 400683

Finish: Polished chrome / Satin nickel metal work

EDNAH

Model	Width (mm)	Proj. (mm)	Lamp
ED 400680	60	470	LED 1.4W
ED 400683	60	500	LED 1.4W

FO Please add suffix for alternate metal finish - Refer page no. 333

Finish Option



EDNAH



ED 400685

Finish: Polished nickel with
off white linen shade



ED 400684

Finish: Polished nickel with
golden brown fabric shade

Model	Width (mm)	Height (mm)	Proj. (mm)	Lamp
ED 400684	200	290	230	E 27 7.5 W LED WW
ED 400685	200	480	230	E 27 7.5 W LED WW + LED 1.4W



Please add suffix for alternate metal finish and shade options - Refer page no. 333-334



ARELLA

Model	Width (mm)	Height (mm)	Lamp
ED 400611	400	650	E 27 7.5 W LED WW
ED 400614	400	550	E 27 7.5 W LED WW



ED 400611

Finish: Polished nickel metal work / dark wenge wood finish with beige pleated fabric shade



ED 400614

Finish: Polished nickel metal work / dark wenge wood finish with beige pleated fabric shade



Please add suffix for alternate metal / wood finish and shade options available - Refer page no. 333-334

ARELLA

Model	Width (mm)	Height (mm)	Lamp
ED 400608	450	510	E 27 7.5 W LED WW
ED 400842	500	650	E 27 7.5 W LED WW



ED 400608

Finish: Polished nickel metal work / dark wenge wood finish with beige pleated fabric shade



Finish: Polished chrome metal / lacquered dark wood with off white fabric shade



ED 400842

Finish: Polished chrome metal / lacquered off white wood with dark brown fabric shade



Please add suffix for alternate metal / wood finish and shade options available - Refer page no. 333-334

ARELLA

Model	Width (mm)	Height (mm)	Lamp
ED 400810	340	650	E 27 7.5 W LED WW
ED 400620	290	550	E 27 7.5 W LED WW



ED 400810

Finish: Polished chrome metal work
with dark wood finish shade



ED 400620

Finish: Polished chrome metal work
with natural wood finish shade



Please add suffix for alternate metal / wood finish and shade options - Refer page no. 333-334

ARELLA

Model	Width (mm)	Height (mm)	Lamp
ED 400624	330	550	E 27 7.5 W LED WW
ED 400624B	380	650	E 27 7.5 W LED WW



ED 400624 / B

Finish: Polished chrome metal work
with natural wood finish shade



Please add suffix for alternate metal / wood finish and shade options - Refer page no. 333-334

ARELLA

Model	Width (mm)	Height (mm)	Lamp
ED 400792	240	1650	E 27 7.5 W LED WW



ED 400792
Finish: Polished chrome metal
work with natural wood finish shade



Please add suffix for alternate metal / wood finish and shade options - Refer page no. 333-334

ARELLA

Model	Width (mm)	Height (mm)	Lamp
ED 400786	380	1650	E 27 7.5 W LED WW

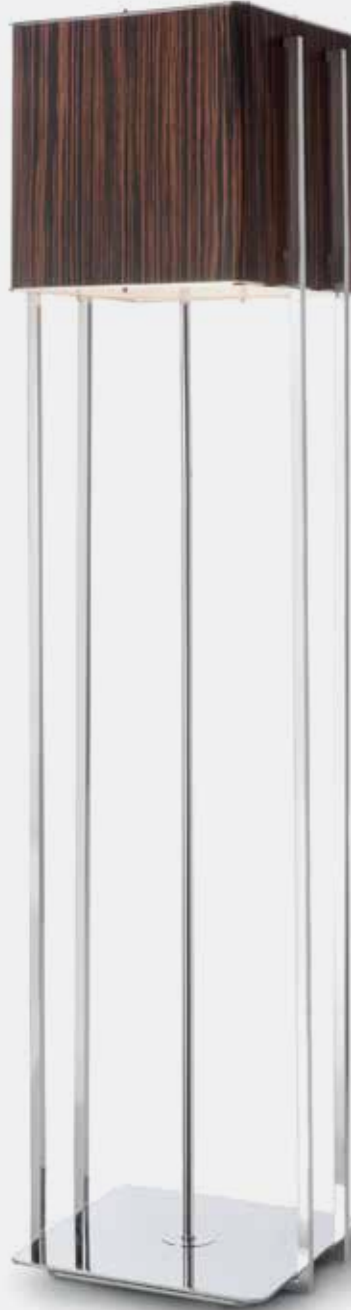

ED 400786

Finish: Polished chrome metal
with dark wood finish shade



Please add suffix for alternate metal / wood finish and shade options - Refer page no. 333-334

**ED 400667**

Finish: Polished chrome metal work
with dark wood finish shade

**ED 400668**

Finish: Polished chrome metal
work with natural wood finish shade

**ED 400669**

Finish: Polished chrome metal work
with dark brown fabric shade

ARELLA

Model	Width (mm)	Height (mm)	Proj. (mm)	Lamp
ED 400667	230	260	150	4 x GU 10 7 W LED WW
ED 400668	100	260	150	2 x GU 10 7 W LED WW
ED 400669	580	340	130	2 x E 14 2.3 W LED WW



Please add suffix for alternate metal / wood finish and shade options - Refer page no. 333-334



Finish: Polished chrome metal work
with dark wood finish shade

ED 400512
Finish: Polished chrome metal work
with natural wood finish shade

ARELLA

Model	Width (mm)	Height (mm)	Lamp
ED 400512	200	500	E 27 7.5 W LED WW

FO Please add suffix for alternate metal / wood finish - Refer page no. 333-334
Finish Option



ED 400896

Finish: Polished chrome / brass
metal work with amber fabric shade

ARELLA

Model	Width (mm)	Height (mm)	Proj. (mm)	Lamp
ED 400896	160	300	200	E 27 7.5 W LED WW
ED 400839	350	800	-	E 27 7.5 W LED WW
ED 400769	500	1800	-	E 27 7.5 W LED WW



ED 400839

Finish: Polished chrome / brass
metal work with amber fabric shade



Please add suffix for alternate metal / wood finish and shade options - Refer page no. 333-334



ED 400769

Finish: Polished chrome / brass
metal work with amber fabric shade





P 071



P 079



P 096

Model	Width (mm)	Height (mm)	Lamp
ED 400531	340	1120	1 x 7.5W 534 3100 K
ED 400546	145	750	1 x 7.5W 534 3100 K



ED 400546

CALYX

Finish: Satin Nickel / Chrome finish

ED 400531



CALYX

Model	Width (mm)	Height (mm)	Lamp
ED 400790	310	1950	E 27 7.5 W LED WW



ED 400790
 Finish: Polished nickel metal work
 with painted matt black shade

FO Please add suffix for alternate metal finish - Refer page no. 333
Finish Option

CALYX

Model	Width (mm)	Height (mm)	Lamp
ED 400783	300	1500	E 14 2.3 W LED WW



ED 400783

Finish: Bronze metal work with
painted matt black shade



Please add suffix for alternate metal finish - Refer page no. 333

CALYX

Model	Width (mm)	Height (mm)	Lamp
ED 400806	100	530	E 14 2.3 W LED WW
ED 400793	200	1520	E 14 2.3 W LED WW



ED 400806
Finish: Polished chrome metal work
with painted matt black shade



ED 400793
Finish: Polished chrome metal work
with painted matt black shade



Please add suffix for alternate metal finish - Refer page no. 333

CALYX

Model	Width (mm)	Height (mm)	Lamp
ED 400800	500	1520	3 x E 14 2.3 W LED WW



ED 400800

Finish: Polished chrome metal work
with painted matt black shade



Please add suffix for alternate metal finish - Refer page no. 333

CALYX

Model	Width (mm)	Height (mm)	Lamp
ED 400621	200	900	1 x E 14 2.3 W LED WW



ED 400621

Finish: Antique brass metal work
with painted matt black shade



Please add suffix for alternate metal finish - Refer page no. 333

CALYX

Model	Width (mm)	Height (mm)	Lamp
ED 400823	200	900	E 14 2.3 W LED WW



ED 400823

Finish: Antique brass metal work
with painted matt black shade



Please add suffix for alternate metal finish - Refer page no. 333

CALYX

Model	Width (mm)	Height (mm)	Lamp
ED 400605	160	420	1 x E 14 2.3 W LED WW
ED 400759	315	2 x E 27 7.5 W LED WW	



ED 400605
Finish: SS metal work with
gold opaque flexible shade



ED 400759
Finish: SS metal work with
gold opaque flexible shade

FO White opaque flexible shade option available

Finish Option



CALYX

Finish: SS metal work with
white opaque flexible shade

Model	Width (mm)	Height (mm)	Lamp
ED 400606	210	730	1 x E 27 7.5 W LED WW
ED 400768	315	1610	3 x E 27 7.5 W LED WW
ED 400768B	315	1840	3 x E 27 7.5 W LED WW



ED 400768



ED 400606



ED 400768B



FO Gold opaque flexible shade option available

Finish Option



CALYX

Model	Width (mm)	Height (mm)	Lamp
ED 400630	360	500	2 x E 14 2.3 W LED WW
ED 400622	350	E 14 2.3 W LED WW	



ED 400630
 Finish: Polished chrome metal work with painted matt black shade



ED 400622
 Finish: Polished chrome metal work with painted matt black shade

FO Please add suffix for alternate metal finish - Refer page no. 333
Finish Option

CALYX

Model	Width (mm)	Height (mm)	Lamp
ED 400763	360	1390	E 14 2.3 W LED WW
ED 400752	360	1410	2 x E 14 2.3 W LED WW



ED 400763
Finish: Polished chrome
metal work with painted
matt black shade



ED 400752
Finish: Polished chrome
metal work with painted
matt black shade

CALYX

Model	Width (mm)	Height (mm)	Lamp
ED 400619	360	670	2 x E 14 2.3 W LED WW
ED 400789	360	1740	2 x E 14 2.3 W LED WW



ED 400619
Finish: Polished chrome metal work with painted matt black shade



ED 400789
Finish: Polished chrome metal work with painted matt black shade

FO Please add suffix for alternate metal finish - Refer page no. 333

Finish Option

CALYX

Model	Width (mm)	Height (mm)	Lamp
ED 400794	380	1600	2 x E 14 2.3 W LED WW
ED 400623	380	500	2 x E 14 2.3 W LED WW



ED 400794
 Finish: Polished chrome
 metal work with painted
 matt black shade



ED 400623
 Finish: Polished chrome
 metal work with painted
 matt black shade

FO Please add suffix for alternate metal finish - Refer page no. 333
Finish Option



ED 400665
 Finish: Bronze metal work with
 painted matt black shade



ED 400875
 Finish: Polished chrome
 metal work with painted
 matt black shade

CALYX

Model	Width (mm)	Height (mm)	Proj. (mm)	Lamp
ED 400665	900	600	300	1 x E 14 2.3 W LED WW
ED 400875	140	220	170	1 x E 27 7.5 W LED WW

FO Please add suffix for alternate metal finish - Refer page no. 333
Finish Option



ED 400666
 Finish: Bronze metal work
 with painted matt black shade

CALYX

Model	Width <i>(mm)</i>	Height <i>(mm)</i>	Proj. <i>(mm)</i>	Lamp
ED 400666	1800	300	1300	3 x E 14 2.3 W LED WW

FO Please add suffix for alternate metal finish - Refer page no. 333
Finish Option



ED 400670
 Finish: Polished chrome
 metal work with painted
 matt off-white shade



ED 400671
 Finish: Polished chrome
 metal work with painted
 matt black shade



ED 400877
 Finish: Polished chrome
 metal work with painted
 matt black shade

CALYX

Model	Width (mm)	Height (mm)	Proj. (mm)	Lamp
ED 400670	350	250	150	3 x E 14 2.3 W LED WW
ED 400671	220	250	325	2 x E 14 2.3 W LED WW
ED 400877	100	550	290	2 x E 14 2.3 W LED WW

FO Please add suffix for alternate metal finish - Refer page no. 333
Finish Option



CALYX

Finish: Polished chrome metal work with
painted black metal shade

Model	Width (mm)	Height (mm)	Lamp
ED 400549	300	570	E 14 2.3 W LED WW
ED 400550	300	1300	E 14 2.3 W LED WW



ED 400549



CALYX

Finish: Polished chrome metal work with
painted black metal shade

ED 400550







ED 400562

Finish: Epoxy powder coated
metal work with black / golden
inner fabric shade

CALYX

Model	Width (mm)	Height (mm)	Lamp
ED 400562	935	1900 - 2400	1 x E40 500W

ED 400563

Finish: Epoxy powder coated
metal work with black / golden
inner fabric shade



Model	Width (mm)	Height (mm)	Lamp
ED 400563	730	1680-2100	1 x E40 500W



ED 400659
Finish: Polished chrome metal work
with dark brown fabric shade



ED 400895
Finish: Polished chrome metal work
with dark brown fabric shade

CALYX

Model	Width (mm)	Height (mm)	Proj. (mm)	Lamp
ED 400659	600	170	100	E 27 7.5 W LED WW
ED 400895	350	850	190	E 27 7.5 W LED WW

FO Please add suffix for alternate metal finish and shade options - Refer page no. 333-334
Finish Option

CALYX

Model	Width (mm)	Height (mm)	Lamp
ED 400618	370	800	E 27 7.5 W LED WW
ED 400787	370	1750	E 27 7.5 W LED WW



ED 400618

Finish: Painted bronze metal finish
with black metal shade and black base



ED 400787

Finish: Painted bronze metal finish
with black metal shade and black base





P 103



P 119



P 128

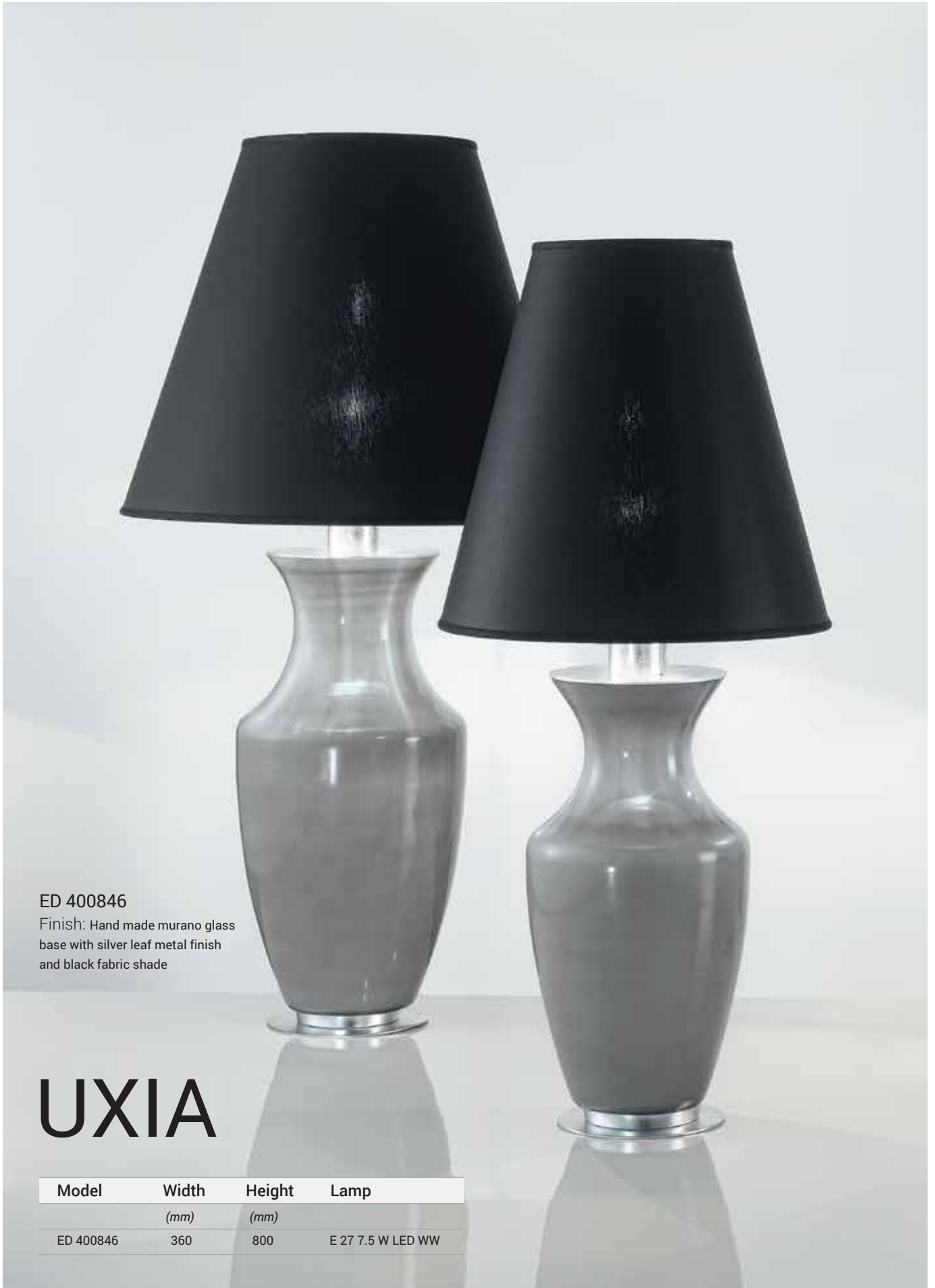

ED 400846

Finish: Hand made murano glass base with silver leaf metal finish and black fabric shade

UXIA

Model	Width	Height	Lamp
	(mm)	(mm)	
ED 400846	360	800	E 27 7.5 W LED WW

Model	Width (mm)	Height (mm)	Lamp
ED 400849	300	810	E 27 7.5 W LED WW
ED 400603	360	700	E 27 7.5 W LED WW
ED 400610	260	530	E 27 7.5 W LED WW

UXIA

Finish: Hand made swirl amber murano glass base with gold leaf metal finish and off white fabric shade



ED 400603

ED 400610

ED 400849



Please add suffix for alternate metal / glass finishes and shade options available - Refer page no. 333-334

UXIA

Finish: Hand made opaque white glass base with gold leaf metal finish and off white fabric shade

Model	Width (mm)	Height (mm)	Lamp
ED 400827	350	780	E 27 7.5 W LED WW
ED 400827B	480	670	E 27 7.5 W LED WW



ED 400827

ED 400827B



Please add suffix for alternate metal / glass finishes and shade options available - Refer page no. 333-334



UXIA

Model	Width (mm)	Height (mm)	Lamp
ED 400847	450	840	E 27 7.5 W LED WW
ED 400850	400	700	E 27 7.5 W LED WW



ED 400847

Finish: High gloss black ceramic base
with off white fabric shade



ED 400850

Finish: Matt cream ceramic base
with coffee brown fabric shade



Please add suffix for alternate metal / ceramic finishes and shade options - Refer page no. 333-334

UXIA

Model	Width (mm)	Height (mm)	Lamp
ED 400601	500	860	E 27 7.5 W LED WW
ED 400607	400	860	E 27 7.5 W LED WW



ED 400601
 Finish: Polished chrome metal work with high gloss white ribbed ceramic base and tussar silk shade



ED 400607
 Finish: Polished chrome metal work with beige ceramic base and golden brown fabric shade



Please add suffix for alternate metal / ceramic finishes and shade options available - Refer page no. 333-334

UXIA

Model	Width (mm)	Height (mm)	Lamp
ED 400835	450	610	E 27 7.5 W LED WW
ED 400836	450	620	E 27 7.5 W LED WW



ED 400835
 Finish: Polished chrome metal work with beige ceramic base and black fabric shade



ED 400836
 Finish: Polished chrome metal work with high gloss black ceramic base and black fabric shade

FO Please add suffix for alternate metal / ceramic finish and shade options available - Refer page no. 333-334
Finish Option





TORIN

Model	Width (mm)	Height (mm)	Lamp
ED 400761	400	640	E 27 7.5 W LED WW
ED 400809	150	320	E 27 7.5 W LED WW

Finish: Satin nickel metal work with solid rock crystals and off white fabric shade



ED 400761



ED 400809

FO Please add suffix for alternate metal / glass finish and shade options - Refer page no. 333-334

Finish Option



ED 400765

TORIN

Model	Width (mm)	Height (mm)	Lamp
ED 400765	500	1800	E 27 7.5 W LED WW
ED 400880	270	690	E 27 7.5 W LED WW

Finish: Satin nickel metal work with solid rock crystals and off white fabric shade



TORIN

ED 400880

Finish: Satin nickel metal work with solid rock crystals and off white fabric shade



FO Please add suffix for alternate metal / glass finish and shade options - Refer page no. 333-334

Finish Option

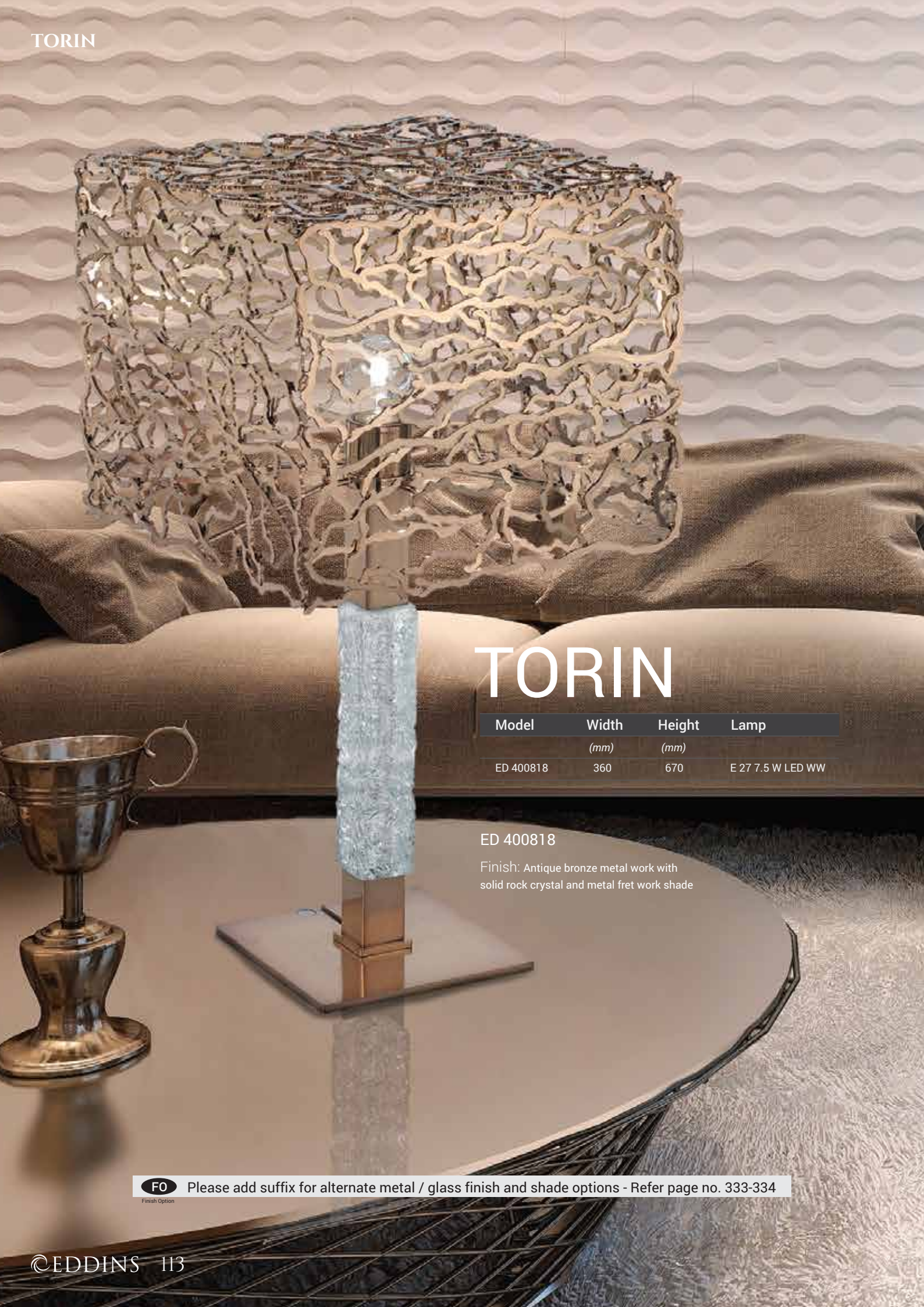

TORIN

Model	Width (mm)	Height (mm)	Lamp
ED 400818	360	670	E 27 7.5 W LED WW

ED 400818

Finish: Antique bronze metal work with solid rock crystal and metal fret work shade

FO Please add suffix for alternate metal / glass finish and shade options - Refer page no. 333-334

Finish Option

TORIN

Model	Width (mm)	Height (mm)	Lamp
ED 400826	360	690	E 27 7.5 W LED WW



ED 400826

Finish: Antique bronze metal work
with solid rock crystal and white fabric shade

FO Please add suffix for alternate metal / glass finish and shade options - Refer page no. 333-334

Finish Option



TORIN

Model	Width (mm)	Height (mm)	Lamp
ED 400830	450	650	E 27 40 W LED WW

Finish: Polished brass metal work with hand made ribbed Murano glass and beige pleated fabric shade

FO Please add suffix for alternate metal / glass finish and shade options - Refer page no. 333-334



TORIN

Model	Width (mm)	Height (mm)	Lamp
ED 400892	450	700	E 27 40 W LED WW

Finish: Polished brass metal work with hand made ribbed Murano glass and beige pleated fabric shade

FO Please add suffix for alternate metal / glass finish and shade options - Refer page no. 333-334

UXIA

Model	Width (mm)	Height (mm)	Lamp
ED 400828	500	850	E 27 7.5 W LED WW
ED 400833	500	520	E 27 7.5 W LED WW

Finish: Polished nickel metal work with
hand blown amber glass and off white fabric shade



ED 400828



ED 400833



Please add suffix for alternate metal / glass finish and shade options - Refer page no. 333-334

UXIA

Model	Width (mm)	Height (mm)	Lamp
ED 400845	400	520	E 27 7.5 W LED WW
ED 400845B	500	850	E 27 7.5 W LED WW

Finish: Hand blown clear glass with black swirl and off white fabric shade



ED 400845



ED 400845B

FO Please add suffix for alternate metal / glass finish and shade options - Refer page no. 333-334
Finish Option

UXIA

Model	Width	Height	Depth	Lamp
	(mm)	(mm)	(mm)	
ED 400831	300	590	450	E 27 7.5 W LED WW



ED 400831

Finish: Silver leaf metal work with
red Murano glass and off-white fabric shade



Please add suffix for alternate metal / glass finish and shade options - Refer page no. 333-334



TORIN

Finish: Polished Chrome metal work with
silver tint hand made murano glass
and black / beige fabric shade

Model	Width (mm)	Height (mm)	Lamp
ED 400838	250	900	E 27 7.5 W LED WW
ED 400840	400	600	E 27 7.5 W LED WW



ED 400838



ED 400840

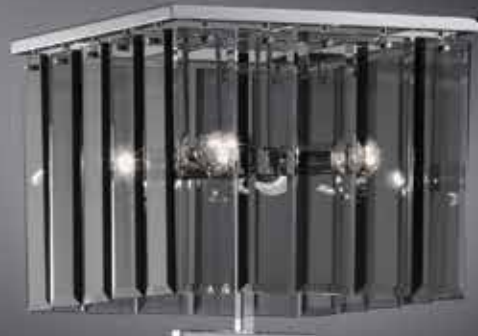

TORIN

Finish: Polished chrome metal work
with Bevelled smoked glass panels

Model	Width (mm)	Height (mm)	Lamp
ED 400770	340	1760	4 x E 14 2.3 W LED WW
ED 400804	210	500	E 27 7.5 W LED WW

ED 400770

ED 400804

FO Please add suffix for alternate metal finish - Refer page no. 333

UXIA

Model	Width (mm)	Height (mm)	Lamp
ED 400843	500	840	E 27 7.5 W LED WW
ED 400844	400	890	E 27 7.5 W LED WW



ED 400843

Finish: Glazed white ceramic base with polished chrome metal work and burgandy shade



ED 400844

Finish: Glazed dark brown ceramic base with polished chrome metal work and off white pleated fabric shade

FO Please add suffix for alternate metal / ceramic finish and shade options - Refer page no. 333-334

Finish Option



TORIN

Finish: Polished gold / chrome metal work with hand made murano glass and beige fabric shade

Model	Width (mm)	Height (mm)	Lamp
ED 400602	450	1080	E 27 7.5 W LED WW
ED 400604	320	670	E 27 7.5 W LED WW



ED 400602



ED 400604

FO Please add suffix for alternate metal / glass finish and shade options - Refer page no. 333-334

Finish Option

TORIN

Model	Width (mm)	Height (mm)	Lamp
ED 400756	450	1680	E 27 7.5 W LED WW
ED 400756B	450	1980	E 27 7.5 W LED WW



ED 400756B
 Finish: Polished gold metal work
 with hand made murano glass
 and ivory fabric shade



ED 400756
 Finish: Polished chrome metal work
 with hand made murano glass
 and ivory fabric shade

FO Please add suffix for alternate metal / glass finish and shade options - Refer page no. 333-334
Finish Option



ED 400854



ED 400711

TORIN

Finish: Polished chrome / gold / copper metal work with hand made murano glass.
Glass options in gold, chrome and copper

Model	Width (mm)	Height (mm)	Proj. (mm)	Lamp
ED 400854	250	400	270	E 27 7.5 W LED WW
ED 400711	530	630	-	3 x E 27 7.5 W LED WW
ED 400764	630	1730	-	3 x E 27 7.5 W LED WW

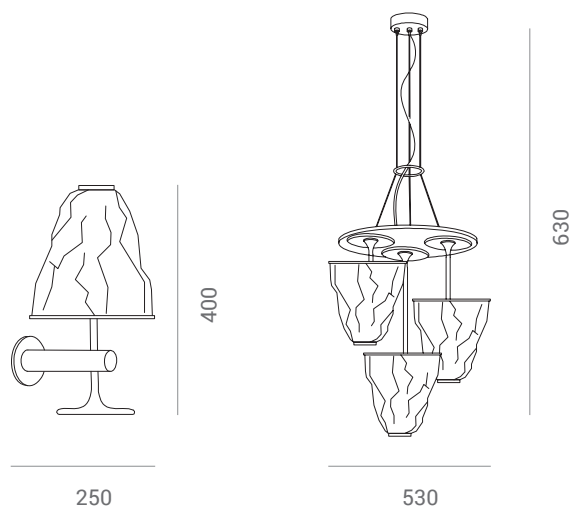

TORIN

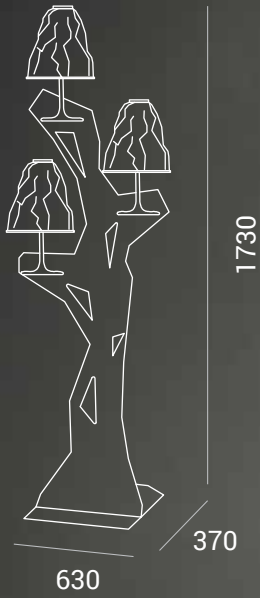

ED 400764

Finish: Polished chrome / gold / copper
metal work with hand made murano glass.
Glass options in gold, chrome and copper





P 134



P 138



P 142



P 147

CLASSIC

Model	Width (mm)	Height (mm)	Lamp
ED 400640	450	760	E 27 7.5 W LED WW
ED 400641	450	760	E 27 7.5 W LED WW
ED 400642	450	770	E 27 7.5 W LED WW



ED 400640
 Finish: Wooden lamp with antique silver
 leaf finish and beige silk fabric shade



ED 400641
 Finish: Wooden lamp with antique silver
 leaf finish and beige silk fabric shade



ED 400642

Finish: Wooden lamp with antique silver leaf finish and black fabric shade

FO

Finish Option

Please add suffix for alternate metal finish and shade options - Refer page no. 333-334



ED 400631
Finish: Crystal table lamp with
silk fabric shade



ED 400632
Finish: Ceramic table lamp with antique
gold leaf finish and pleated fabric shade



Please add suffix for alternate metal / glass finish and shade options - Refer page no. 333-334

CLASSIC

Model	Width (mm)	Height (mm)	Lamp
ED 400631	500	730	E 27 7.5 W LED WW
ED 400632	450	700	E 27 7.5 W LED WW
ED 400633	500	940	E 27 7.5 W LED WW



ED 400633

Finish: Ceramic table lamp with antique gold leaf finish and black fabric shade



Please add suffix for alternate metal / ceramic finish and shade options - Refer page no. 333-334

CLASSIC

Model	Width (mm)	Height (mm)	Lamp
ED 400628	500	880	E 27 7.5 W LED WW
ED 400629	500	760	E 27 7.5 W LED WW



ED 400628
Finish: Wooden lamp with antique silver
leaf finish and burgundy fabric shade



ED 400629
Finish: Wooden lamp with antique silver
leaf finish and white fabric shade



PATTU

Finish: Hand made Murano glass base with silver leaf metal finish and beige fabric shade

Model	Width (mm)	Height (mm)	Lamp
ED 400837	350	580	E 27 7.5 W LED WW
ED 400837 B	350	580	E 27 7.5 W LED WW



ED 400837B

ED 400837

FO Please add suffix for alternate shade options - Refer page no. 333-334



ED 400848

Finish: Hand made murano glass base with silver / gold leaf metal finish and beige fabric shade

Model	Width (mm)	Height (mm)	Lamp
ED 400848	380	680	E 27 7.5 W LED WW



ED 400634
Finish: Crystal table lamp with aged brass and pleated beige shade



ED 400635
Finish: Crystal table lamp with aged brass and beige silk fabric shade with golden trim

CLASSIC

Model	Width (mm)	Height (mm)	Lamp
ED 400634	350	570	E 27 7.5 W LED WW
ED 400635	400	560	E 27 7.5 W LED WW
ED 400636	450	690	E 27 7.5 W LED WW



ED 400636

Finish: Crystal table lamp with aged brass and beige silk fabric shade with golden trim



Please add suffix for alternate metal / glass finish and shade options - Refer page no. 333-334



ED 400637

Finish: Amber murano glass
table lamp with aged brass and
champagne silk fabric shade



ED 400638

Finish: Amber gold murano
glass table lamp with aged brass
and beige silk fabric shade

CLASSIC

Model	Width (mm)	Height (mm)	Lamp
ED 400637	400	630	E 27 7.5 W LED WW
ED 400638	400	710	E 27 7.5 W LED WW
ED 400639	400	660	E 27 7.5 W LED WW



ED 400639

Finish: Amber murano glass
table lamp with aged brass and
pleated beige shade



Please add suffix for alternate metal finish and shade options - Refer page no. 333-334

CLASSIC

Model	Width (mm)	Height (mm)	Lamp
ED 400647	400	670	3 x E 27 7.5 W LED WW
ED 400648	400	590	4 x E 27 7.5 W LED WW
ED 400649	450	730	4 x E 27 7.5 W LED WW



ED 400647
 Finish: Gold finish table lamp
 with black marble and
 black silk fabric shade



ED 400648
 Finish: Polished Nickel finish
 table lamp with black marble
 and black silk fabric shade

FO Please add suffix for alternate metal finish and shade options - Refer page no. 333-334



ED 400649

Finish: Antique brass table lamp with
dark red marble and pleated fabric shade

CLASSIC



ED 400650

Finish: Gold finish table lamp with white onyx and beige fabric shade

Model	Width (mm)	Height (mm)	Lamp
ED 400650	450	760	4 x E 27 7.5 W LED WW
ED 400580	400	640	E 27 7.5 W LED WW
ED 400554	550	1790	4 x E 27 7.5 W LED WW



ED 400580

Finish: Gold finish table lamp with white marble and beige fabric shade

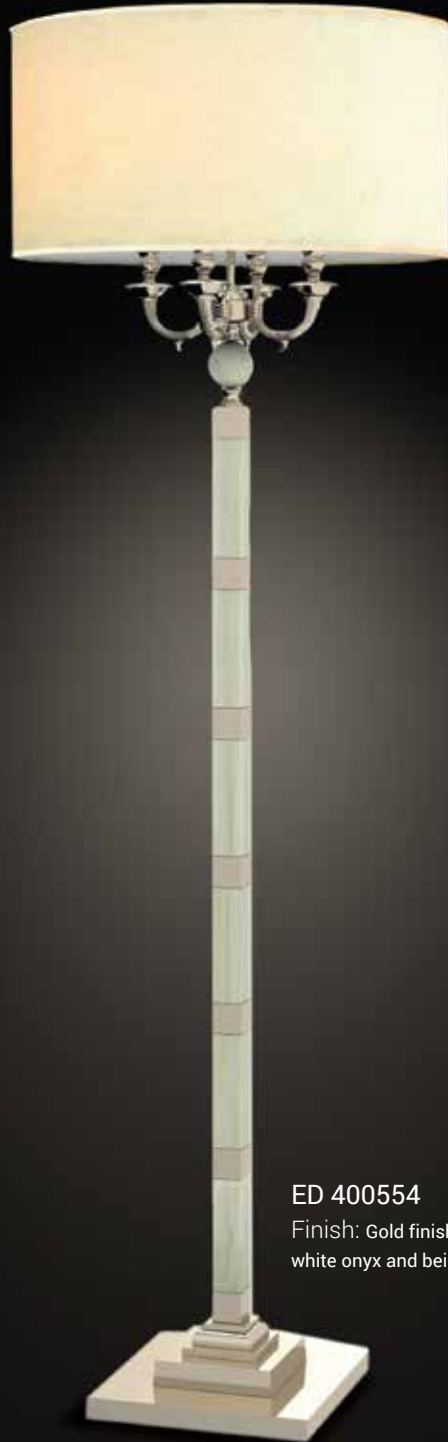

ED 400554

Finish: Gold finish floor lamp with
white onyx and beige fabric shade

FO Please add suffix for alternate metal finish and shade options - Refer page no. 333-334
Finish Option

CLASSIC



ED 400581
 Finish: Hand carved wooden table lamp finished in antique gold with beige fabric shade

Model	Width (mm)	Height (mm)	Lamp
ED 400581	450	750	E 27 7.5 W LED WW
ED 400582	460	750	E 27 7.5 W LED WW
ED 400555	500	1730	E 27 7.5 W LED WW



ED 400582
 Finish: Hand carved wooden table lamp finished in antique silver and gold with beige fabric shade



ED 400555

Finish: Hand carved wooden floor lamp finished in antique gold with beige fabric shade



Please add suffix for alternate metal finish and shade options - Refer page no. 333-334

CLASSIC

Model	Width (mm)	Height (mm)	Lamp
ED 400643	400	600	3 x E 27 7.5 W LED WW
ED 400644	450	630	3 x E 27 7.5 W LED WW
ED 400553	400	1680	3 x E 27 7.5 W LED WW



ED 400643
Finish: Polished nickel metal work
with dark brown fabric shade



ED 400644
Finish: Polished nickel metal work
with brown fabric shade



ED 400553

Finish: Polished nickel metal work
with dark brown fabric shade

FO Please add suffix for alternate metal finish and shade options - Refer page no. 333-334
Finish Option

CLASSIC



ED 400645

Finish: Polished nickel metal work
with off-white fabric shade

Model	Width (mm)	Height (mm)	Proj. (mm)	Lamp
ED 400645	400	480	240	2 x E 27 7.5 W LED WW
ED 400646	400	470	300	2 x E 27 7.5 W LED WW
ED 400695	400	680	-	2 x E 27 7.5 W LED WW
ED 400696	400	710	-	2 x E 27 7.5 W LED WW



ED 400646

Finish: Polished nickel metal work
with burgandy fabric shade



ED 400695

Finish: Polished nickel metal work
with off-white fabric shade



ED 400696

Finish: Polished nickel metal work
with burgandy fabric shade



Please add suffix for alternate metal finish and shade options - Refer page no. 333-334

CLASSIC



ED 400694

Finish: Polished nickel metal work
with off-white fabric shade

Model	Width (mm)	Height (mm)	Proj. (mm)	Lamp
ED 400694	280	390	200	2 x E 14 2.3 W LED WW
ED 400627	380	680	-	2 x E 14 2.3 W LED WW
ED 400552	380	680	-	2 x E 14 2.3 W LED WW



ED 400627

Finish: Polished nickel metal work
with off-white fabric shade



Please add suffix for alternate metal finish and shade options - Refer page no. 333-334



ED 400552

Finish: Polished nickel metal work
with off white fabric lamp shade



ROHA

Model	Width (mm)	Height (mm)	Lamp
ED 400754	700	330	1 x 2.2W LED Kit
ED 400754B	500	240	1 x 2.2W LED Kit



ED 400754B
Finish: Matt white



ED 400754
Finish: Matt white / Matt black





P 163



P 170



P 174



ED 400748

Finish: Polished chrome metal work
with hand made opaque glass balls

Model	Length (mm)	Width (mm)	Height (mm)	Lamp
ED 400748	1310	540	1500	Downlight: 3 x LED 3.2W 22 x G4 2W 12V LED WW
ED 400749	780	780	1500	12 x G4 2W 12V LED WW

ELLIPSE



Please add suffix for alternate metal / glass finish - Refer page no. 333



ED 400749

Finish: Polished chrome metal work
with hand made opaque glass balls



ED 400750

Finish: Polished chrome metal work
with hand made black glass balls

ELLIPSE

Model	Length (mm)	Width (mm)	Height (mm)	Lamp
ED 400750	1810	540	2000	Downlight: 4 x LED 3.2W 34 x G4 2W 12V LED WW
ED 400501	1050	1050	1500	20 x G4 2W 12V LED WW

FO Please add suffix for alternate metal / glass finish - Refer page no. 333
Finish Option



ED 400501

Finish: Finish: Polished chrome metal work
with hand made black glass balls





ED 400522

Finish: Polished stainless steel metal work
with full cut octagonal crystals

ARELIE

Model	Width (mm)	Height (mm)	Lamp
ED 400522	2200	180	36 x G9 2.5W LED WW





ED 400523

Finish: Polished stainless steel metal work
with full cut octagonal crystals

ARELIE

Model	Width (mm)	Height (mm)	Lamp
ED 400523	2400	150	32 x G9 2.5W LED WW



ED 400514

Finish: Matt white / black / gold metal band
with golden / SS strings and Swarovski crystal elements

ARELIE

Model	Length	Width	Height	Lamp
	(mm)	(mm)	(mm)	
ED 400514	1300	450	1600	12 x G9 2.5W LED WW

Pure steel branches

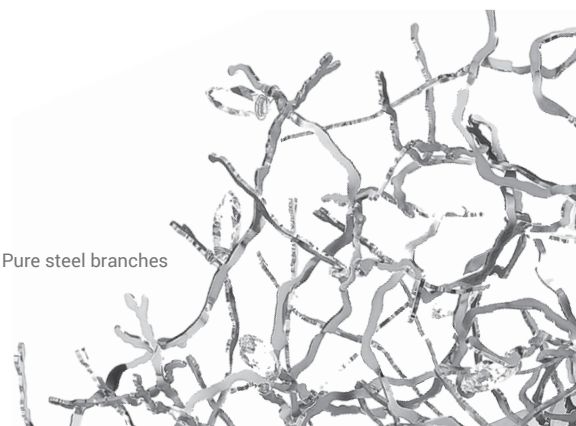

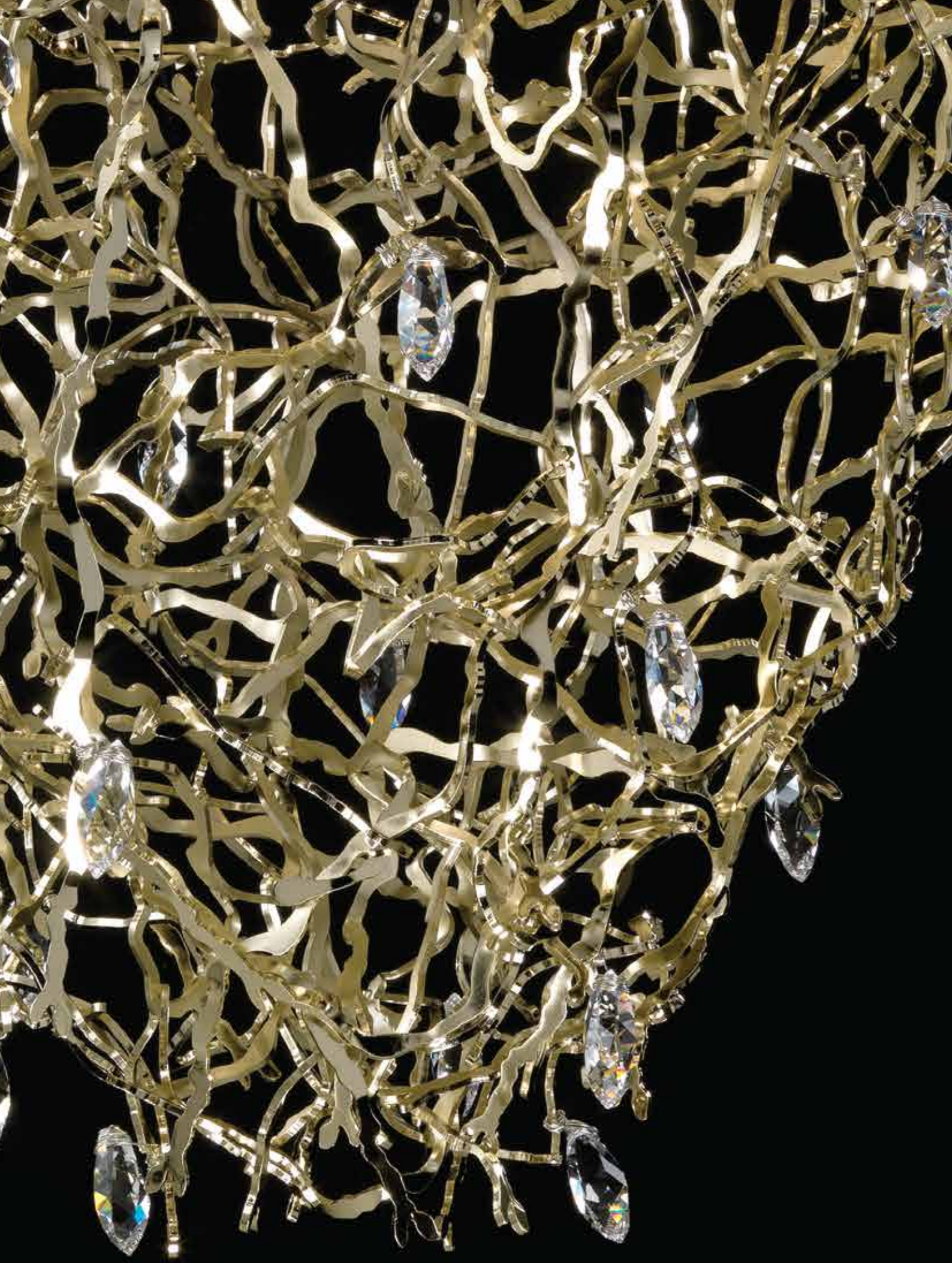



ED 400502

Finish: Polished chrome metal work
with hand made black glass balls

ELLIPSE

Model	Length (mm)	Width (mm)	Height (mm)	Lamp
ED 400502	880	880	2000	Downlight: 9 x LED 3.2W 20 x G4 2W 12V LED WW



Please add suffix for alternate metal / glass finish - Refer page no. 333



Mounted in cluster

ED 400743

Finish: Polished chrome metal work
with hand made black glass balls

Model	Dia (mm)	Height (mm)	Lamp
ED 400743	200	4500 (Adj)	10 x G9 2.5W LED WW

ARELIE



ED 400853

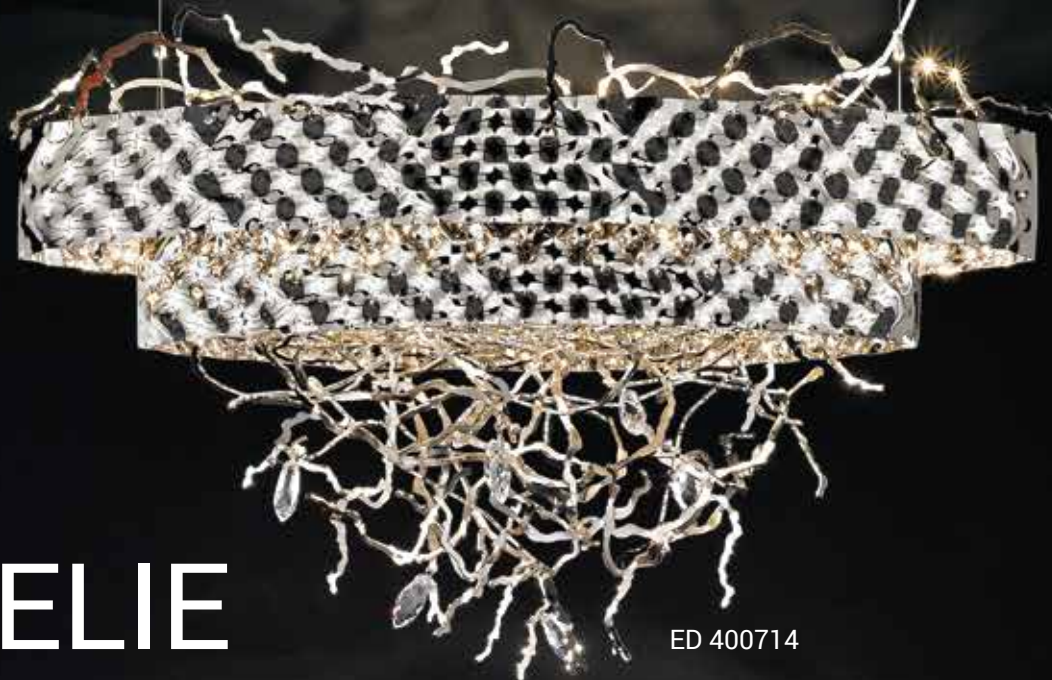
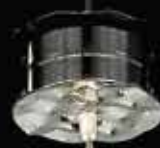

ED 400714

ARELIE

Finish: Matt white / black / gold metal band
with golden / SS strings and Swarovski crystal elements

Model	Length (mm)	Width (mm)	Proj. (mm)	Height (mm)	Lamp
ED 400714	800	250	-	1500	6 x G9 2.5W LED WW
ED 400853	410	-	140	500	1 x 2G11 18W



ED 400701

ARELIE

Finish: Matt white / black / gold metal band
with golden / SS strings and Swarovski crystal elements

Model	Dia (mm)	Height (mm)	Lamp
ED 400701	1000	1200	12 x G9 2.5W LED WW



ED 400504

Finish: Polished chrome metal work with
handmade glass balls and clear murano glass arms

ELLIPSE

Model	Width (mm)	Height (mm)	Proj. (mm)	Lamp
ED 400504	410	4500 (Adj)	-	6 x G9 2.5W LED WW
ED 400866	440	790	360	3 x G9 2.5W LED WW

FO Please add suffix for alternate metal / glass finish - Refer page no. 333



Mounted in cluster

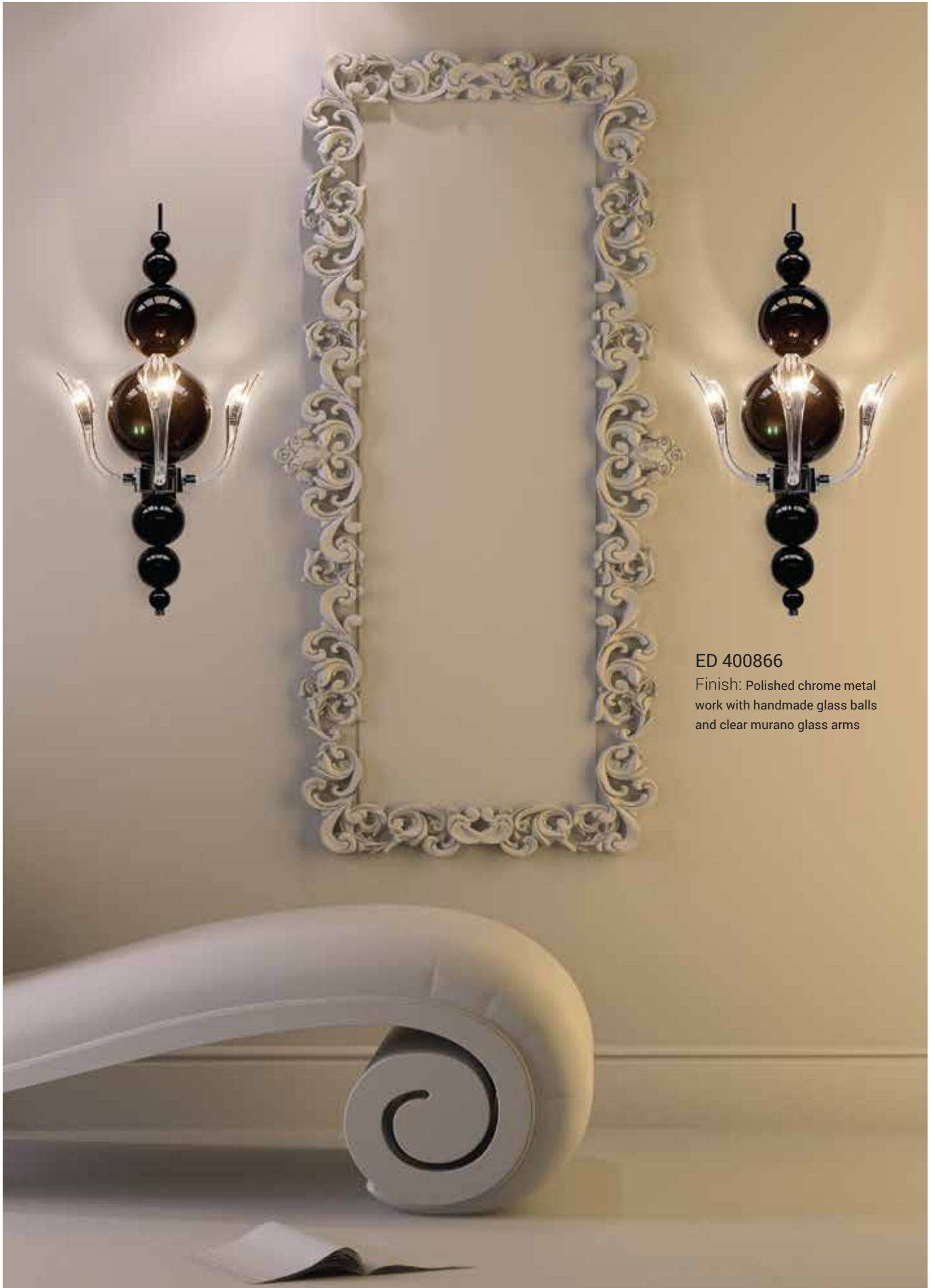

ED 400866

Finish: Polished chrome metal
work with handmade glass balls
and clear murano glass arms

ELLIPSE

Model	Width (mm)	Height (mm)	Lamp
ED 400741	410	4500 (Adj)	4 x G9 2.5W LED WW



ED 400741

Finish: Polished chrome with handmade opaque white glass balls and clear Murano glass arms



Mounted in cluster

FO Please add suffix for alternate metal / glass finish - Refer page no. 333

Finish Option

ELLIPSE

ED 400798

Finish: Polished chrome metal
work with full cut crystals

Model	Length (mm)	Width (mm)	Height (mm)	Lamp
ED 400798	1850	500	1800	6 x G9 2.5W LED WW



FO Please add suffix for alternate metal finish - Refer page no. 333

Finish Option



ED 400751

Finish: Glossy white with full cut crystals

ARELIE

Model	Length (mm)	Width (mm)	Height (mm)	Lamp
ED 400751	1850	500	1800	6 x G9 2.5W LED WW

FO Please add suffix for alternate metal finish - Refer page no. 333

Finish Option



ED 400503

Finish: Polished chrome metal work
with full cut crystals



ARELIE

Model	Width (mm)	Height (mm)	Lamp
ED 400503	620	90	6 x G9 2.5W LED WW



ED 400861

Finish: Matt white / black / gold metal band
with golden / SS strings and Swarovski crystal elements

ARELIE

Model	Width (mm)	Height (mm)	Proj. (mm)	Lamp
ED 400861	410	500	140	1 x 2G11 18W
ED 400515	600	1500	-	10 x G9 2.5W LED WW



ED 400515

Finish: Matt white / black / gold metal band
with golden / SS strings and Swarovski crystal elements

ARELIE

Finish: Matt white / black / gold metal band
with golden / SS strings and Swarovski crystal elements

Model	Length (mm)	Width (mm)	Height (mm)	Lamp
ED 400811	250	120	520	3 x G9 2.5W LED WW
ED 400799	380	260	1780	5 x G9 2.5W LED WW

ED 400811



ED 400799





ED 400516

Finish: Matt white / black / gold metal band
with golden / SS strings and Swarovski crystal elements

Model	Dia (mm)	Height (mm)	Lamp
ED 400516	400	1400	6 x G9 2.5W LED WW





ED 400729 / B



ARELIE

Finish: SS metal work with
Copper / silver / opaque flexible shade

Model	Width (mm)	Height (mm)	Lamp
ED 400729	500	1900	3 x E 27 7.5 W LED WW
ED 400729B	360	1700	1 x E 27 7.5 W LED WW

FO Gold colour option available
Finish Option

ELLIPSE

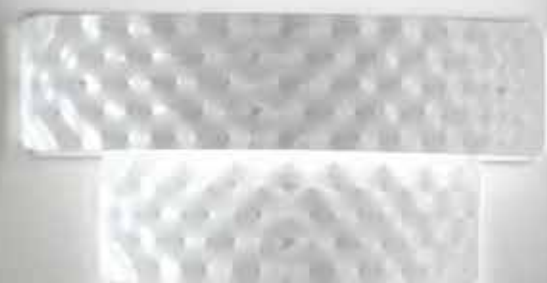

ED 400883

Finish: Metal finish available in highly polished steel or gold or satin white

Model	Width (mm)	Height (mm)	Proj. (mm)	Lamp
ED 400883	420	210	110	1 x 2G11 18W
ED 400626	130	300	-	1 x G9 2.5W LED WW
ED 400551	410	1710	-	1 x E 27 7.5 W LED WW



ED 400626

Finish: Metal finish available in highly polished steel or gold or satin white

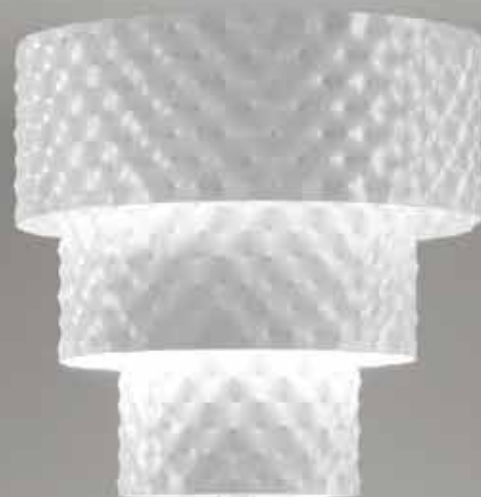

ED 400551

Finish: Metal finish available in highly polished steel or gold or satin white

ELLIPSE

Model	Width (mm)	Height (mm)	Lamp
ED 400517	810	1200	6 x G9 2.5W LED WW



ED 400517

Finish: Metal finish available in
highly polished steel or gold or satin white







P 189

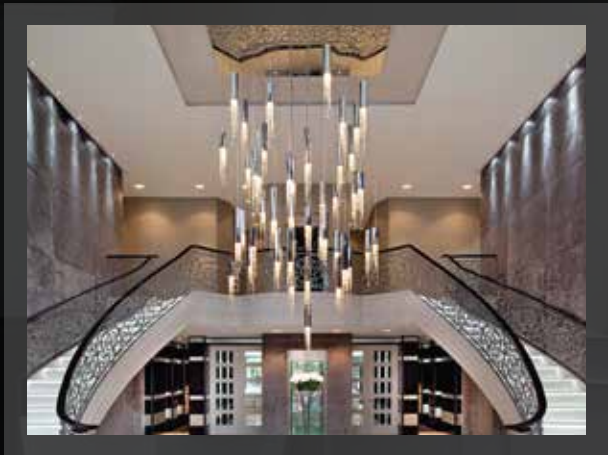

P 196



P 201



ED 400738

Finish: Polished chrome metal work with
handmade clear murano glass

MAEVI

Model	Width (mm)	Height (mm)	Lamp
ED 400712	140	1500	G9 2.5W LED WW
ED 400738	140	100	G9 2.5W LED WW



ED 400712

Finish: Satin nickel metal work
with handmade clear murano glass



CLUSTER OF MAEVI



ED 400735 / B / C

Finish: Handmade silver coated

Murano glass



MAEVI

Model	Dia (mm)	Height (mm)	Lamp
ED 400735	800	1650	8 x G9 2.5W LED WW
ED 400735 B	930	1600	8 x G9 2.5W LED WW
ED 400735 C	1350	1700	10 x G9 2.5W LED WW



Clear Murano glass option available





ED 400730

Finish: Polished chrome with handmade silver coated Murano glass



ED 400740

Finish: Polished chrome with handmade silver coated Murano glass



Clear Murano glass option available

MAEVI

Model	Length (mm)	Width (mm)	Height (mm)	Lamp
ED 400730	1850	420	1500	14 x G9 2.5W LED WW
ED 400740	400	420	1500	4 x G9 2.5W LED WW





ED 400744 / B

Finish: Polished chrome with handmade silver coated Murano glass

MAEVI

Model	Width (mm)	Height (mm)	Lamp
ED 400744	150	120	G9 2.5W LED WW
ED 400744B	150	180	G9 2.5W LED WW
ED 400745	270	190	G9 2.5W LED WW
ED 400745B	270	190	G9 2.5W LED WW



ED 400745B

Finish: Painted white with handmade silver coated Murano glass



ED 400745

Finish: Satin nickel with handmade silver coated Murano glass



Clear Murano glass option available



ED 400869

Finish: Polished chrome with handmade silver coated Murano glass

MAEVI

Model	Width (mm)	Height (mm)	Proj. (mm)	Lamp
ED 400869	150	180	275	1 x G9 2.5W LED WW



Clear Murano glass option available



ED 400879



ED 400731

MAEVI

Finish: Polished chrome / satin nickel
metal work with crystals

Model	Width (mm)	Height (mm)	Lamp
ED 400879	800	3500	32 x GU 10 7 W LED WW
ED 400731	400	1800	8 x GU 10 7 W LED WW



MAEVI

Finish: Polished chrome / satin nickel
metal work with crystals

Model	Width (mm)	Height (mm)	Proj. (mm)	Lamp
ED 400795	230	1100	180	6 x GU 10 7 W LED WW



ED 400795



ED 400673



ED 400734



ED 400732

MAEVI

Finish: Polished chrome metal work
with matt black tube

Model	Dia (mm)	Height (mm)	Proj. (mm)	Lamp
ED 400732	70	1750	-	1 x GU 10 7 W LED WW
ED 400734	180	1150	-	1 x GU 4 2.5W LED WW
ED 400673	80	630	80	1 x GU 4 2.5W LED WW

MAEVI

Model	Length (mm)	Width (mm)	Height (mm)	Lamp
ED 400547	980	20	2500	LED 35 W 2670 Lumen 3100K
ED 400547 B	1500	20	2500	LED 50 W 4015 Lumen 3100K
ED 400547 C	1760	20	2500	LED 57 W 4680 Lumen 3100K

ED 400547 / B / C

Finish: Satin nickel /
chrome finish metal work

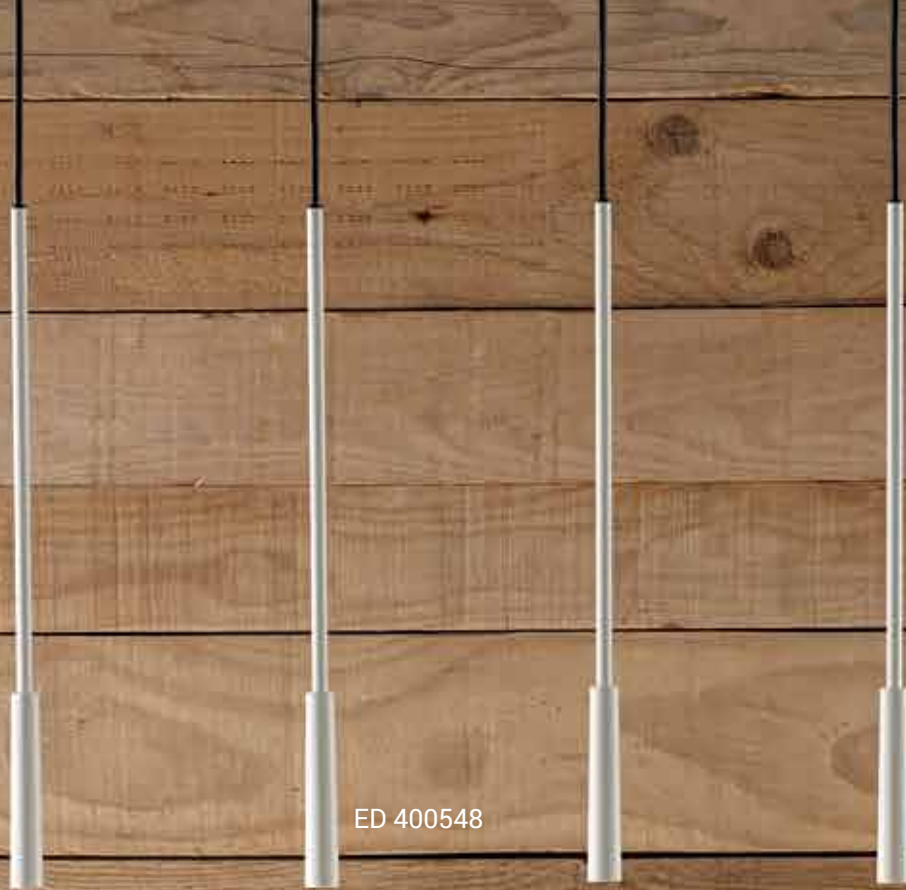

ED 400548

MAEVI

Finish: White / Satin Nickel / Black finish metal work



Model	Width (mm)	Height (mm)	Lamp
ED 400548	20	2000	2 W 100 Lumen 3000K







Designer - Zaha Hadid

ED 400709

Finish: Black flexi-polycarbonate

MAEVI

Model	Width (mm)	Height (mm)	Lamp
ED 400709	900	2700	6 x E 27 7.5 W LED WW

FO Transparent flexi-polycarbonate option available

Finish Option



Designer - Zaha Hadid

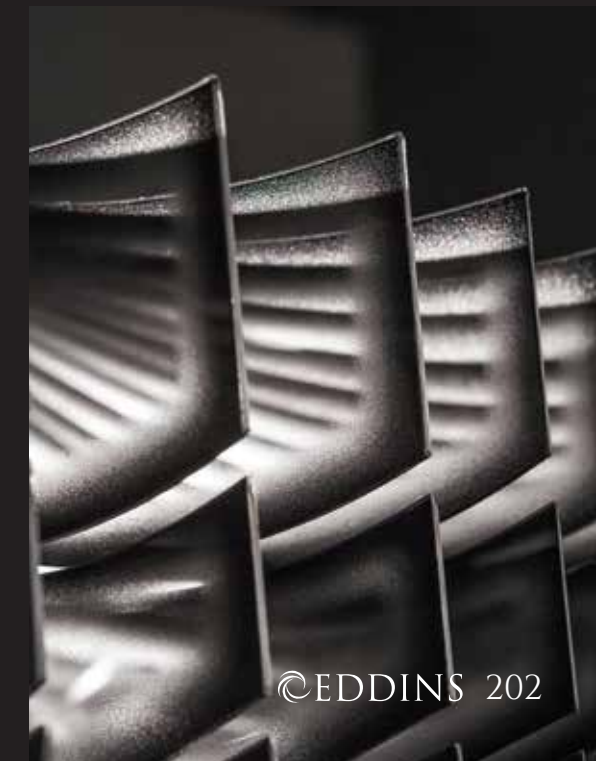



ED 400513 / B / C / D

Finish: Black flexible polycarbonate



Finish: Transparent flexible polycarbonate

MAEVI

Model	Width (mm)	Height (mm)	Lamp
ED 400513	750	2800	6 x E 27 7.5 W LED WW
ED 400513B	600	2600	4 x E 27 7.5 W LED WW
ED 400513C	520	2400	3 x E 27 7.5 W LED WW
ED 400513D	450	2250	2 x E 27 7.5 W LED WW

Designer - Zaha Hadid





ED 400733

Finish: Frosted flexible polycarbonate

MAEVI

Model	Length	Width	Height	Lamp
	(mm)	(mm)	(mm)	
ED 400733	1000	90	1400	LED: 30W 3000 Lumen





Billionaire Mansion & Sumosan
Designer - Prospect Design International



P 211



P 216



P 218



P 221



ED 400511

Finish: Polished chrome metal work with natural wood finish/beige fabric shade and diffuser

DECO

Model	Dia (mm)	Height (mm)	Lamp
ED 400511	620	360	3 x E 27 7.5 W LED WW

FO Please add suffix for alternate metal / wood finish and shade options - Refer page no. 333-334



ED 400564 / B

Finish: Satin nickel metal work with beige fabric shade

Model	Width	Height	Lamp
	<i>(mm)</i>	<i>(mm)</i>	
ED 400564	540	250	2 x E 27 7.5 W LED WW
ED 400564 B	750	250	2 x E 27 7.5 W LED WW





ED 400706 / B / C

Finish: Full cut crystals with matt black details

PEARL

Model	Dia (mm)	Height (mm)	Lamp
ED 400706	600	300	6 x G9 2.5W LED WW
ED 400706 B	1000	500	18 x G9 2.5W LED WW
ED 400706 C	1800	550	24 x G9 2.5W LED WW



ED 400505 / B / C

Finish: Full cut crystals with glossy white details

PEARL

Model	Dia (mm)	Height (mm)	Lamp
ED 400505	600	300	6 x G9 2.5W LED WW
ED 400505 B	1000	500	18 x G9 2.5W LED WW
ED 400505 C	1800	550	24 x G9 2.5W LED WW





ED 400506 / B / C

Finish: Full cut crystals with glossy white details

PEARL

Model	Dia (mm)	Height (mm)	Lamp
ED 400506	600	550	6 x G9 2.5W LED WW
ED 400506 B	1000	550	13 x G9 2.5W LED WW
ED 400506 C	1800	1050	37 x G9 2.5W LED WW

FO Please add suffix for alternate metal finish - Refer page no. 333

Finish Option





ED 400569

DECO

Finish: Black epoxy powder coated outer
with reflector in white

Model	Dia (mm)	Height (mm)	Lamp
ED 400569	600	300	E 27 7.5 W LED WW





ED 400507 / B / C

Finish: Glossy black with full-cut crystals

PEARL

Model	Dia (mm)	Height (mm)	Lamp
ED 400507	600	300	6 x G9 2.5W LED WW
ED 400507B	1000	500	18 x G9 2.5W LED WW
ED 400507C	1800	550	24 x G9 2.5W LED WW



Please add suffix for alternate metal finish - Refer page no. 333

Finish Option



ED 400507 C

Finish: Glossy black with full-cut crystals





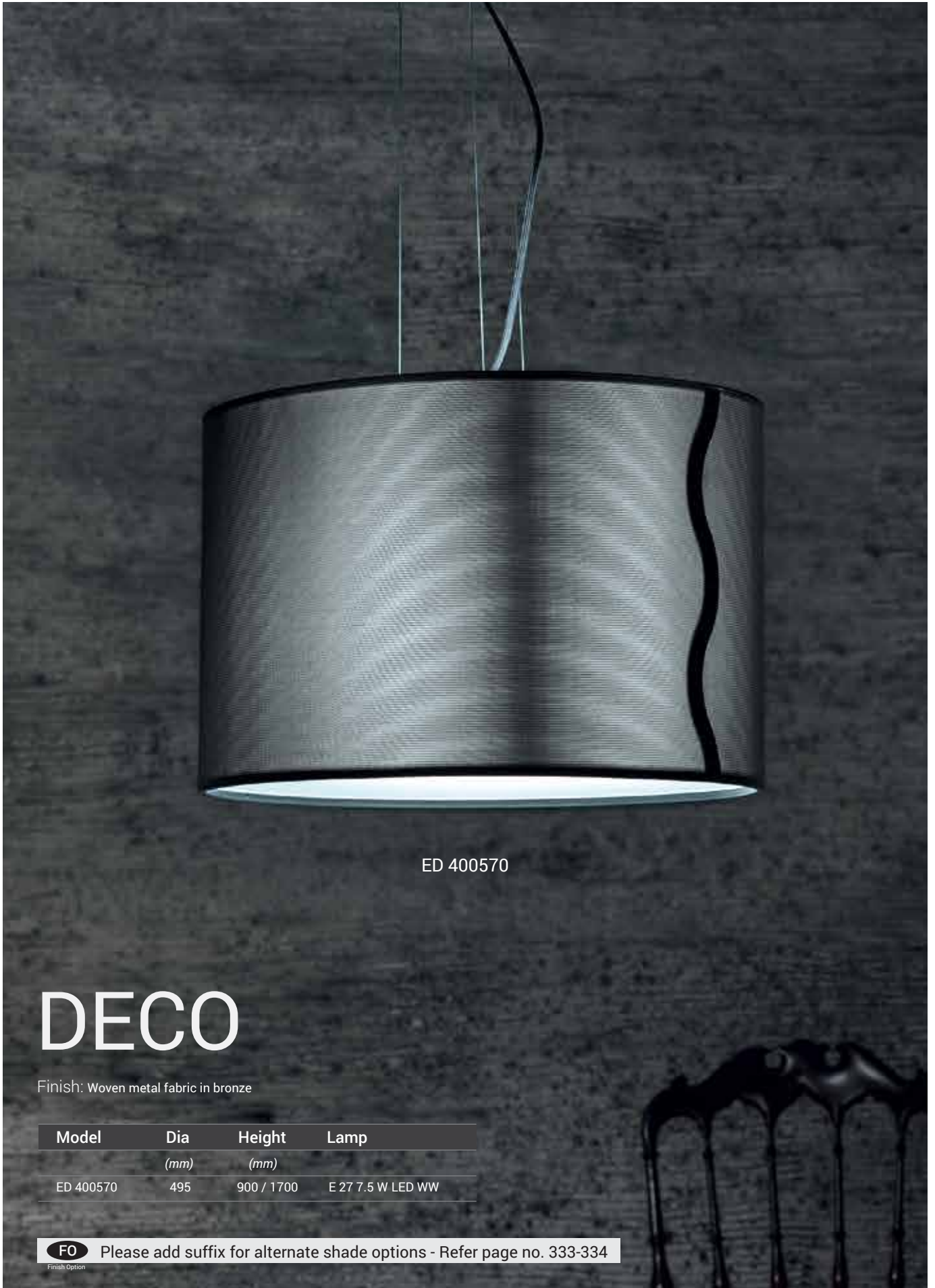

ED 400570

DECO

Finish: Woven metal fabric in bronze

Model	Dia (mm)	Height (mm)	Lamp
ED 400570	495	900 / 1700	E 27 7.5 W LED WW

FO Please add suffix for alternate shade options - Refer page no. 333-334
Finish Option







DECO

Finish: Polished chrome or gold metal work with
ribbed Murano glass in clear / white / gold leaf / silver leaf

Model	Width (mm)	Height (mm)	Lamp
ED 400572	620	1220	10 x G9 2.5W LED WW
ED 400573	240	1220	1 x E 27 7.5 W LED WW



ED 400572

DECO



ED 400573



ED 400574 B



ED 400574

DECO

Finish: Polished chrome or gold metal work with ribbed Murano glass in clear / white / gold leaf / silver leaf

Model	Width (mm)	Height (mm)	Proj. (mm)	Lamp
ED 400574	240	640	170	4 x G9 2.5W LED WW
ED 400574 B	170	430	110	2 x G9 2.5W LED WW
ED 400575	1000	1450	-	10 x G9 2.5W LED WW



ED 400575





P 231



P 238



P 243



ED 400576 / B



ED 400577



ED 400545 / B / C

LEGACY

Finish: These magnificent Georgian style lanterns are made from solid brass casting and hand finished with curved glass to make perfect round sided lanterns

Model	Width (mm)	Height (mm)	Lamp
ED 400576	470	1110	6 x E 14 2.3 W LED WW
ED 400576B	570	1280	9 x E 14 2.3 W LED WW
ED 400577	550	1200	6 x E 14 2.3 W LED WW
ED 400545	260	580	4 x E 14 2.3 W LED WW
ED 400545B	310	610	4 x E 14 2.3 W LED WW
ED 400545C	380	680	4 x E 14 2.3 W LED WW





ED 400451



ED 400452



ED 400453 / B

LEGACY

Finish: Solid Brass casting polished and hand finished

Model	Width (mm)	Height (mm)	Proj. (mm)	Lamp
ED 400451	280	380	150	3 x E 14 2.3 W LED WW
ED 400452	430	600	230	3 x E 14 2.3 W LED WW
ED 400453	70	420	120	1 x E 14 2.3 W LED WW
ED 400453B	180	420	90	2 x E 14 2.3 W LED WW



ED 400454



ED 400455

LEGACY

Finish: Solid Brass casting polished and hand finished

Model	Width (mm)	Height (mm)	Proj. (mm)	Lamp
ED 400454	450	680	270	5 x E 14 2.3 W LED WW
ED 400455	350	680	200	2 x E 14 2.3 W LED WW



ED 400456



ED 400457



ED 400458

LEGACY

Finish: Solid Brass casting polished and hand finished

Model	Width (mm)	Height (mm)	Proj. (mm)	Lamp
ED 400456	290	640	110	2 x E 14 2.3 W LED WW
ED 400457	70	390	140	2 x E 14 2.3 W LED WW
ED 400458	190	370	90	1 x E 14 2.3 W LED WW



ED 400459



ED 400460

LEGACY

Finish: Solid Brass casting polished and hand finished

Model	Width <i>(mm)</i>	Height <i>(mm)</i>	Proj. <i>(mm)</i>	Lamp
ED 400459	290	640	170	5 x E 14 2.3 W LED WW
ED 400460	290	650	170	3 x E 14 2.3 W LED WW



ED 400461



ED 400462

LEGACY

Finish: Solid Brass casting polished and hand finished

Model	Width (mm)	Height (mm)	Proj. (mm)	Lamp
ED 400461	290	640	200	3 x E 14 2.3 W LED WW
ED 400462	290	650	140	2 x E 14 2.3 W LED WW



ED 400464



ED 400463

LEGACY

Finish: Solid Brass casting polished and hand finished

Model	Width (mm)	Height (mm)	Proj. (mm)	Lamp
ED 400463	290	640	220	5 x E 14 2.3 W LED WW
ED 400464	290	650	330	9 x E 14 2.3 W LED WW



ED 400465



ED 400467



ED 400466

LEGACY

Finish: Solid Brass casting polished and hand finished

Model	Width (mm)	Height (mm)	Proj. (mm)	Lamp
ED 400465	460	880	280	5 x E 14 2.3 W LED WW
ED 400466	370	670	220	5 x E 14 2.3 W LED WW
ED 400467	600	1250	350	5 x E 14 2.3 W LED WW



ED 400468



ED 400469 / B

LEGACY

Finish: Solid Brass casting polished and hand finished

Model	Width (mm)	Height (mm)	Proj. (mm)	Lamp
ED 400468	410	700	250	3 x E 14 2.3 W LED WW
ED 400469	570	900	350	3 x E 14 2.3 W LED WW
ED 400469B	560	970	360	3 x E 14 2.3 W LED WW







ED 400470

LEGACY



ED 400471



ED 400472

Model	Width (mm)	Height (mm)	Proj. (mm)	Lamp
ED 400470	330	250	200	2 x E 27 7.5 W LED WW
ED 400471	220	400	210	2 x E 27 7.5 W LED WW
ED 400472	270	460	200	2 x E 27 7.5 W LED WW

Finish: Satin brass metal work with scavo glass



ED 400543

Finish: Antique gold metal work with opal acrylic diffuser



ED 400473

Finish: Satin brass metal work with opal acrylic diffuser

LEGACY

Model	Width (mm)	Height (mm)	Proj. (mm)	Lamp
ED 400473	350	180	230	2 x E 14 2.3 W LED WW
ED 400543	1220	2200	-	12 X E 27 7.5 W LED WW

LEGACY

Model	Width (mm)	Height (mm)	Lamp
ED 400583	380	700	1 x E 27 7.5 W LED WW
ED 400557	450	1600	1 x E 27 7.5 W LED WW

Finish: Polished brass metal work with white fabric shade



ED 400583



ED 400557



ED 400544

Finish: Polished brass metal work
with white fabric shade

LEGACY

Model	Width (mm)	Height (mm)	Lamp
ED 400544	1210	650	8 x E 14 2.3 W LED WW



Please add suffix for alternate shade options - Refer page no. 333-334

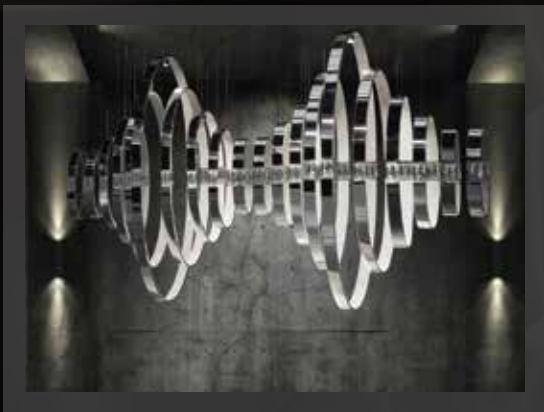

P 252

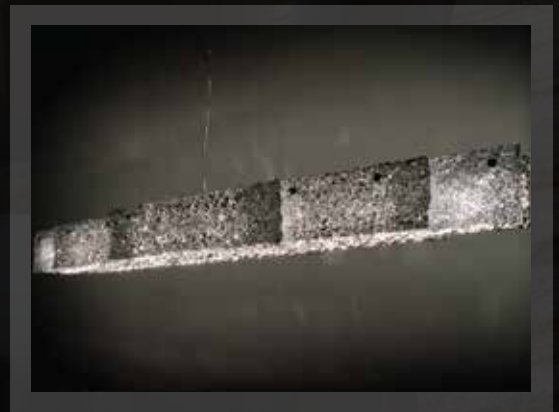

P 259



P 266



P 269



ED 400707

Finish: Satin nickel / 24K gold plated / silver brass metal work with hand made Murano glass with gold or silver crystal highlights



ED 400672

ESTEEM

Model	Width (mm)	Height (mm)	Lamp
ED 400672	130	680	2 x G9 2.5W LED WW
ED 400707	1000	1150	16 x G9 2.5W LED WW



ESTEEM

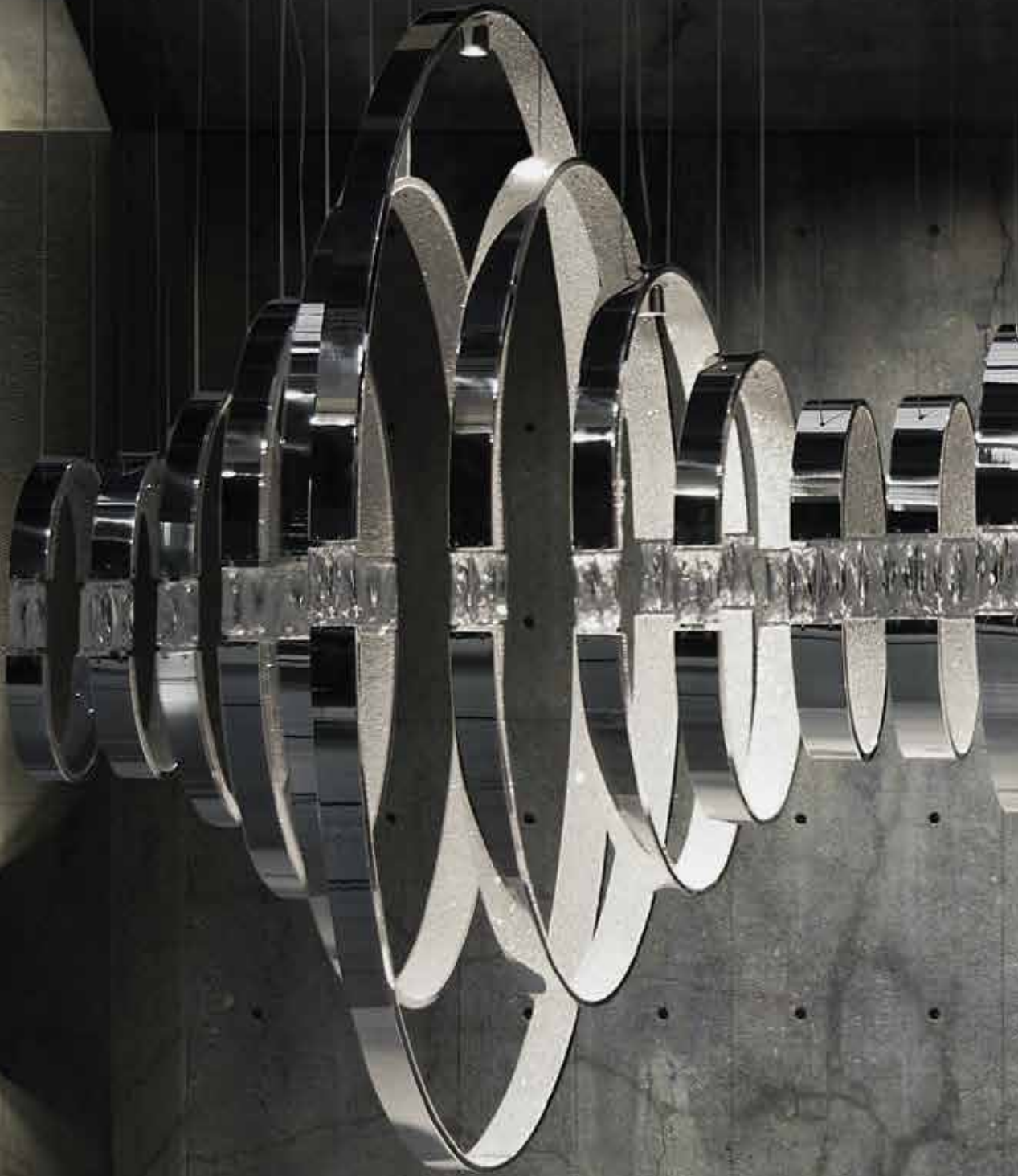

ESTEEM



Finish: Polished SS metal work with Swarovski crystal



ESTEEM

CREATE YOUR OWN CONFIGURATION WITH SIZES 1 TO 5

Finish: Polished stainless steel with Swarovski crystal



Sizes	Model	Dia (mm)	Height (mm)	Thickness (mm)	Lamp
Size 1	ED 400578	100	320	50	1xLED 4.5W
Size 2	ED 400578B	135	420	50	1xLED 4.5W
Size 3	ED 400578C	200	580	50	1xLED 4.5W
Size 4	ED 400578D	295	780	50	1xLED 4.5W
Size 5	ED 400578E	400	1080	50	1xLED 4.5W

Ceiling box: 100 x 45 x 40 mm / Distance between cables: 60 mm

Inspirational ideas

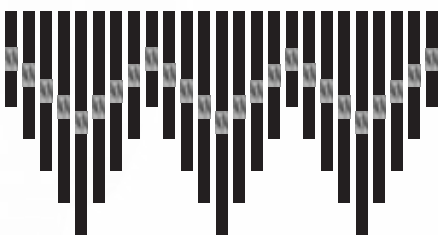

ESTEEM

Model	Width (mm)	Height (mm)	Lamp
ED 400579	1200	1650	18 x G9 2.5W LED WW
ED 400579B	1000	1550	18 x G9 2.5W LED WW
ED 400579C	620	1070	10 x G9 2.5W LED WW



ED 400579 / B / C

Finish: Polished brass metal work with
hand made Murano glass with golden highlights

ESTEEM

Model	Width (mm)	Height (mm)	Lamp
ED 400882	350	500	E 27 7.5 W LED WW

Finish: Polished brass metal work with
hand made Murano glass with golden highlights



ED 400882



ED 400891



ED 400705B



ED 400705

ESTEEM

Finish: Polished gold / chrome metal work
with floral murano glass and swarovski elements

Model	Width (mm)	Height (mm)	Proj. (mm)	Lamp
ED 400891	360	700	180	6 x G4 2W 12V LED WW + 1W LED
ED 400705	500	900	-	12 x G4 2W 12V LED WW + 1 x GU 10 7 W LED WW
ED 400705B	240	500	-	6 x G4 2W 12V LED WW + 1W LED





ED 400870 / B / C
Finish: silver coated Murano glass

Model	Width (mm)	Height (mm)	Proj. (mm)	Lamp
ED 400870	250	150	90	1 x G9 2.5W LED WW
ED 400870B	400	150	90	2 x G9 2.5W LED WW
ED 400870C	600	150	90	3 x G9 2.5W LED WW



FO Please add suffix CMG for clear Murano glass
Finish Option

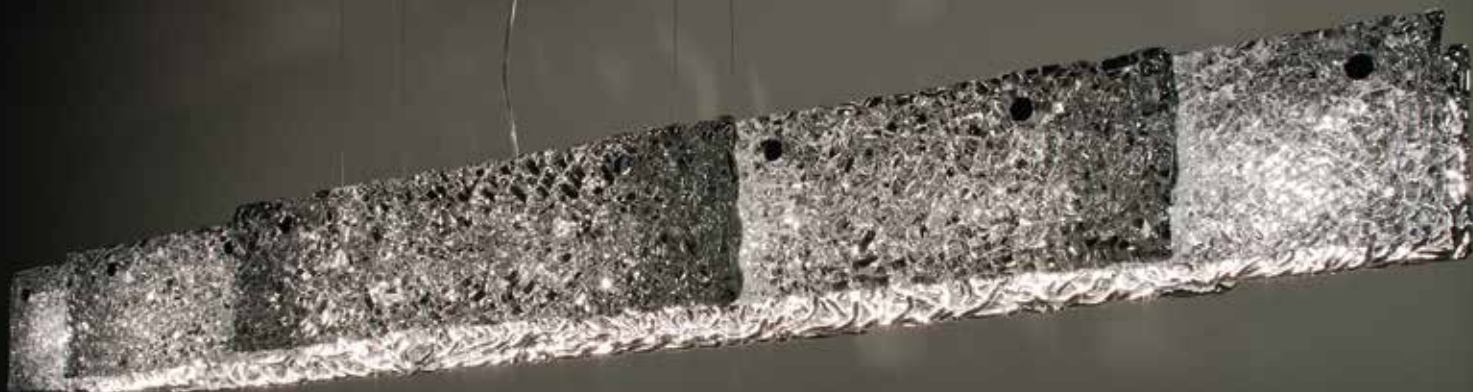

ED 400739B
Finish: Silver coated Murano glass

ESTEEM



ED 400739
Finish: Silver coated Murano glass

Model	Length (mm)	Width (mm)	Height (mm)	Lamp
ED 400739	1060	165	1650	5 x G9 2.5W LED WW
ED 400739 B	1570	225	1650	8 x G9 2.5W LED WW



ESTEEM

Model	Dia (mm)	Height (mm)	Lamp
ED 400720	450	2300	6 x GU 10 7 W LED WW
ED 400526	380	1100	8 x G9 2.5W LED WW
ED 400527	300	1100	6 x G9 2.5W LED WW

Finish: Polished chrome / gold plated / satin black nickel
metal work with hand made Murano glass



ED 400720



ED 400527

ED 400526



ED 400529

Finish: Polished chrome / gold plated /
satin black nickel metal work
with hand made Murano glass

ED 400528

Finish: Polished chrome / gold plated /
satin black nickel metal work
with hand made Murano glass

Model	Dia (mm)	Height (mm)	Lamp
ED 400528	940	1400	12 x G9 2.5W LED WW
ED 400529	750	1400	8 x G9 2.5W LED WW

ESTEEM

Model	Length (mm)	Width (mm)	Height (mm)	Lamp
ED 400530	960	280	1400	8 x G9 2.5W LED WW

Finish: Polished chrome / gold plated /
satin black nickel metal work
with hand made Murano glass



ED 400530

ESTEEM

Finish: Polished chrome / gold plated /
satin black nickel metal work
with hand made Murano glass



ED 400876B



ED 400876



ED 400693

Model	Width (mm)	Height (mm)	Proj. (mm)	Lamp
ED 400876	220	450	90	3 x G9 2.5W LED WW
ED 400876B	225	500	180	2 x G9 2.5W LED WW
ED 400693	60	410	130	1 x G9 2.5W LED WW



ED 400702

Finish: Polished chrome / gold plated /
satin black nickel metal work
with hand made Murano glass

Model	Dia (mm)	Height (mm)	Lamp
ED 400702	500	1300	10 x G9 2.5W LED WW







ED 400584

Finish: Polished nickel metal work
with swarovski crystals



ESTEEM

Finish: Polished nickel metal work
with swarovski crystals

Model	Width (mm)	Height (mm)	Proj. (mm)	Lamp
ED 400584	950	450	-	9 x G9 2.5W LED WW
ED 400585	400	1700	-	6 x G9 2.5W LED WW
ED 400586	360	190	160	2 x G9 2.5W LED WW

ED 400584 is also available in diameter 650mm, 1200mm, 1500mm and 2000mm



ED 400585



ED 400586



Marriott Hotel
Designer - WA International



P 274

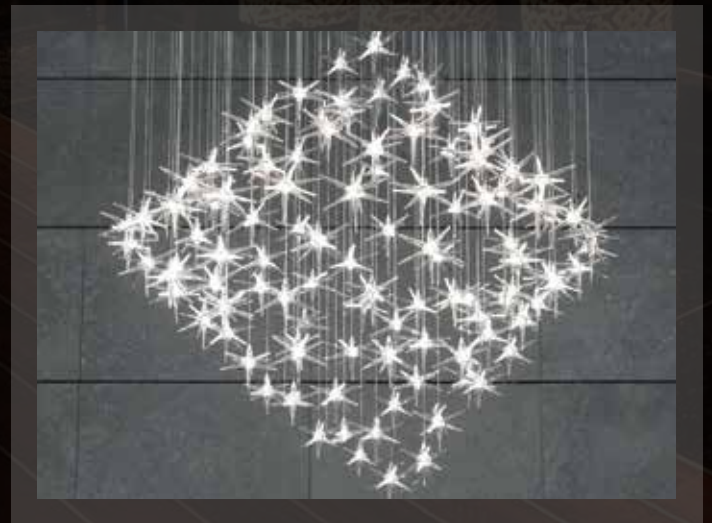

P 284



P 304



P 312



BESPOKE

Bespoke wall light with clear glass tubes

Model	Width (mm)	Height (mm)	Proj. (mm)	Lamp
ED 400587	500	600	400	LED 27W

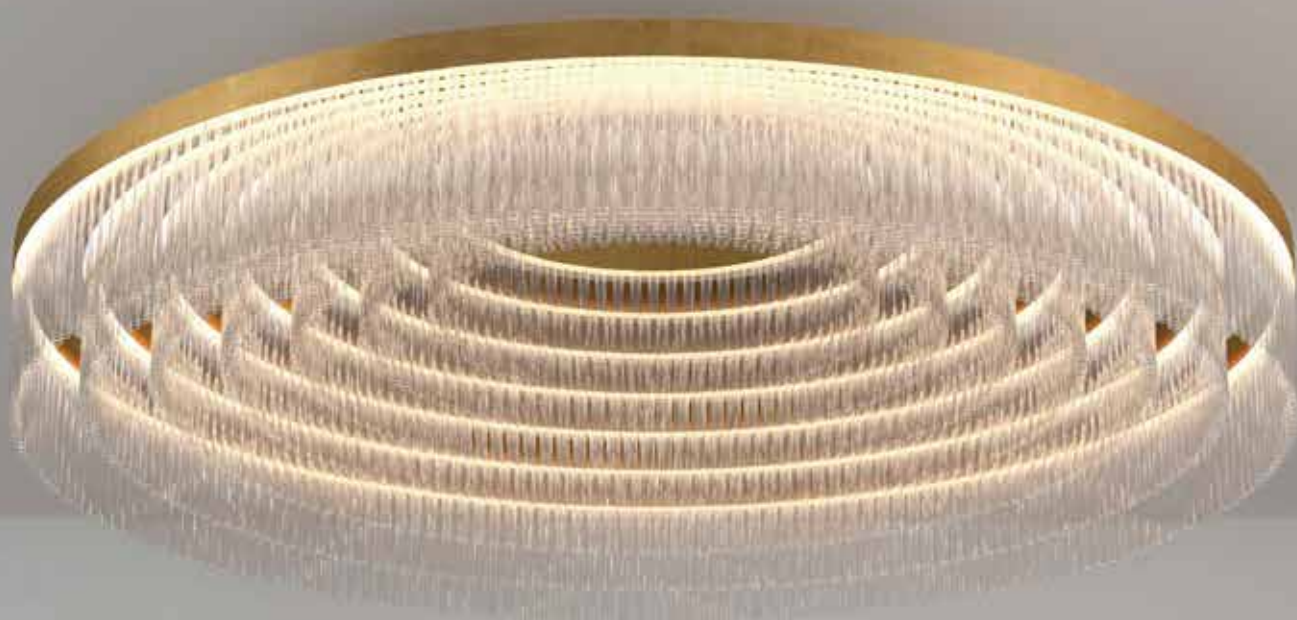

BESPOKE

Bespoke chandelier with clear glass tubes

Model	Width (mm)	Height (mm)	Lamp
ED 400723	2800	1000	LED 510W





BESPOKE

Bespoke chandelier with mirror glass ceiling plate
and falling leaves in handmade glass

Model	Width (mm)	Height (mm)	Lamp
ED 400595	1300	3500	LED 26 x 3W 12V





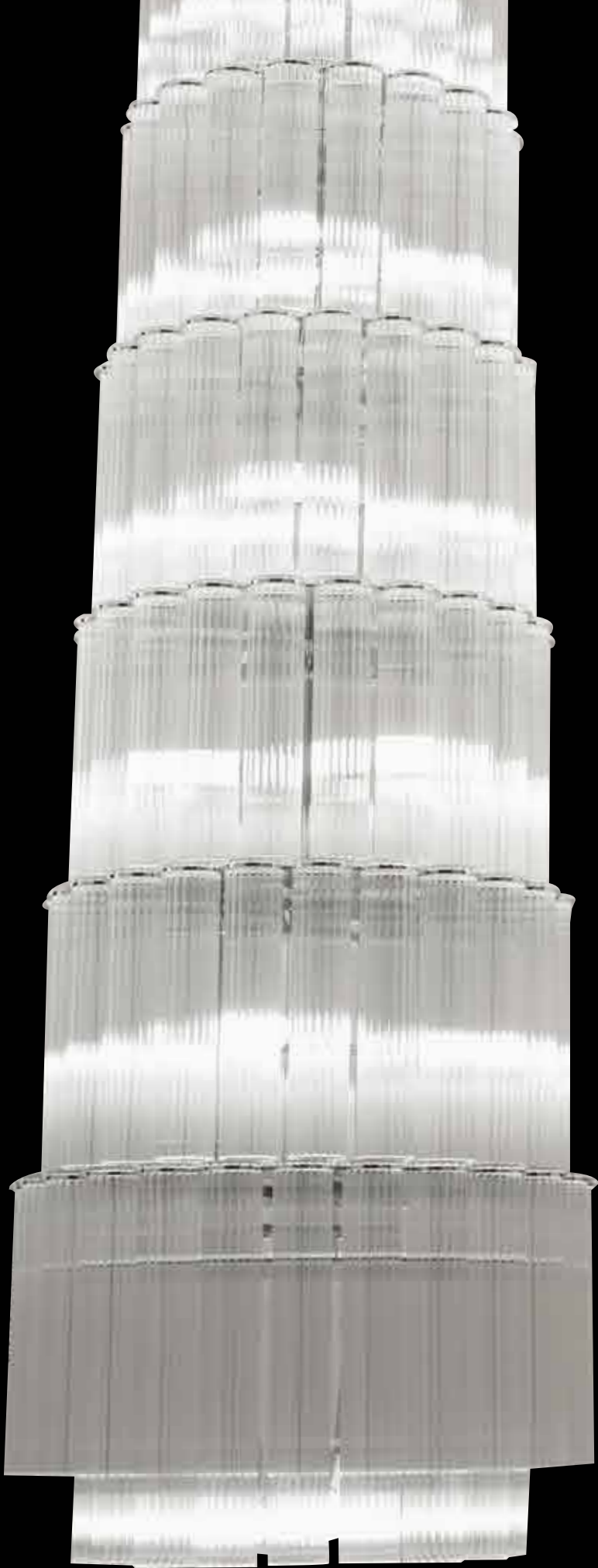

ED 400704

Bespoke chandelier with handmade
ribbed Murano glass

BESPOKE

Model	Width (mm)	Height (mm)	Lamp
ED 400704	760	5700	54 x E 14 2.3 W LED WW





BESPOKE

Bespoke chandelier with clear glass tubes and polished gold / chrome metal work with diffused LED lighting

Model	Width (mm)	Height (mm)	Lamp
ED 400483	1500	3000	LED 525W



BESPOKE

Bespoke chandelier with clear glass tubes and polished copper metal work with diffused LED lighting

Model	Width (mm)	Height (mm)	Lamp
ED 400592	1500	3500	LED 200W

BESPOKE

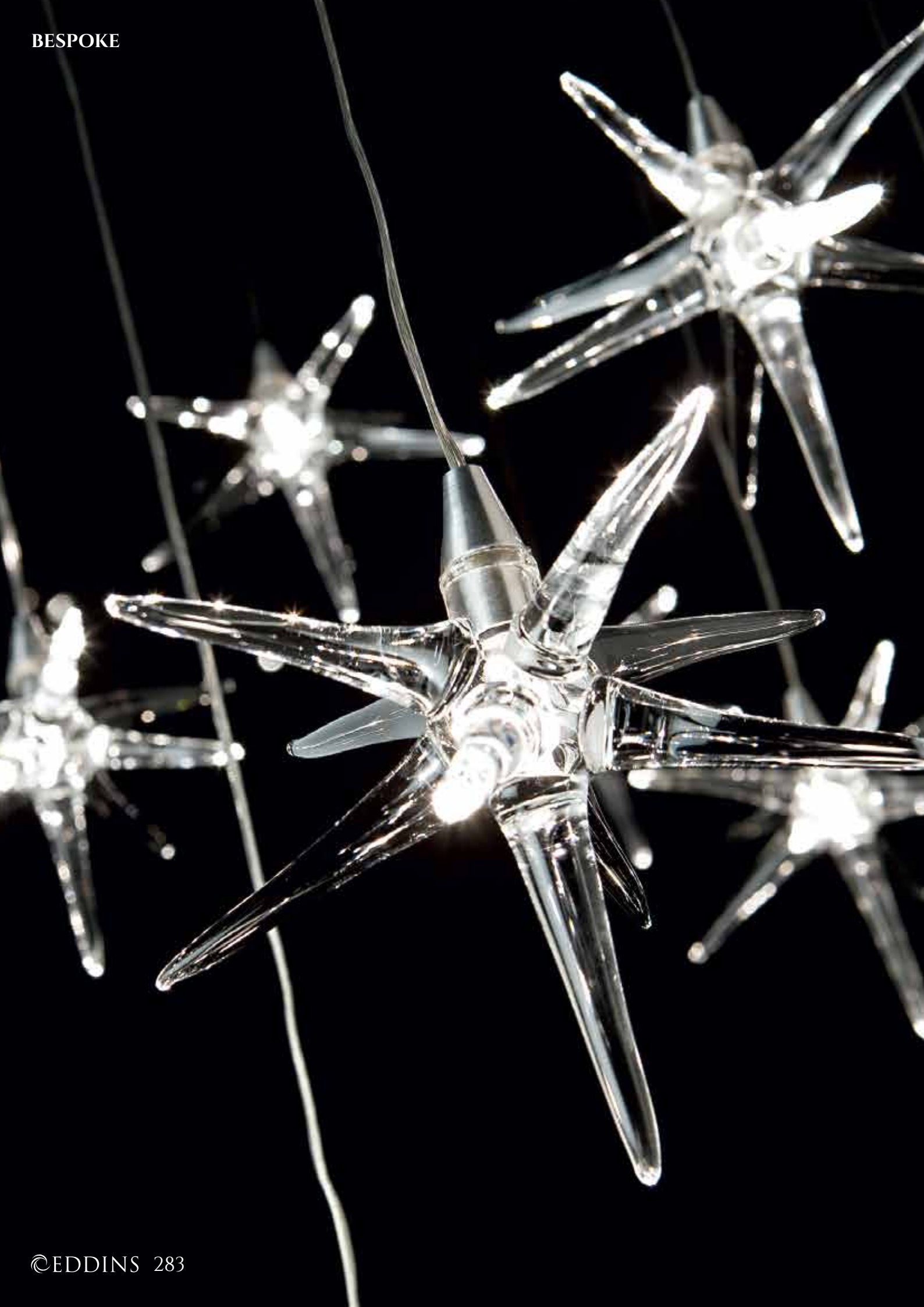

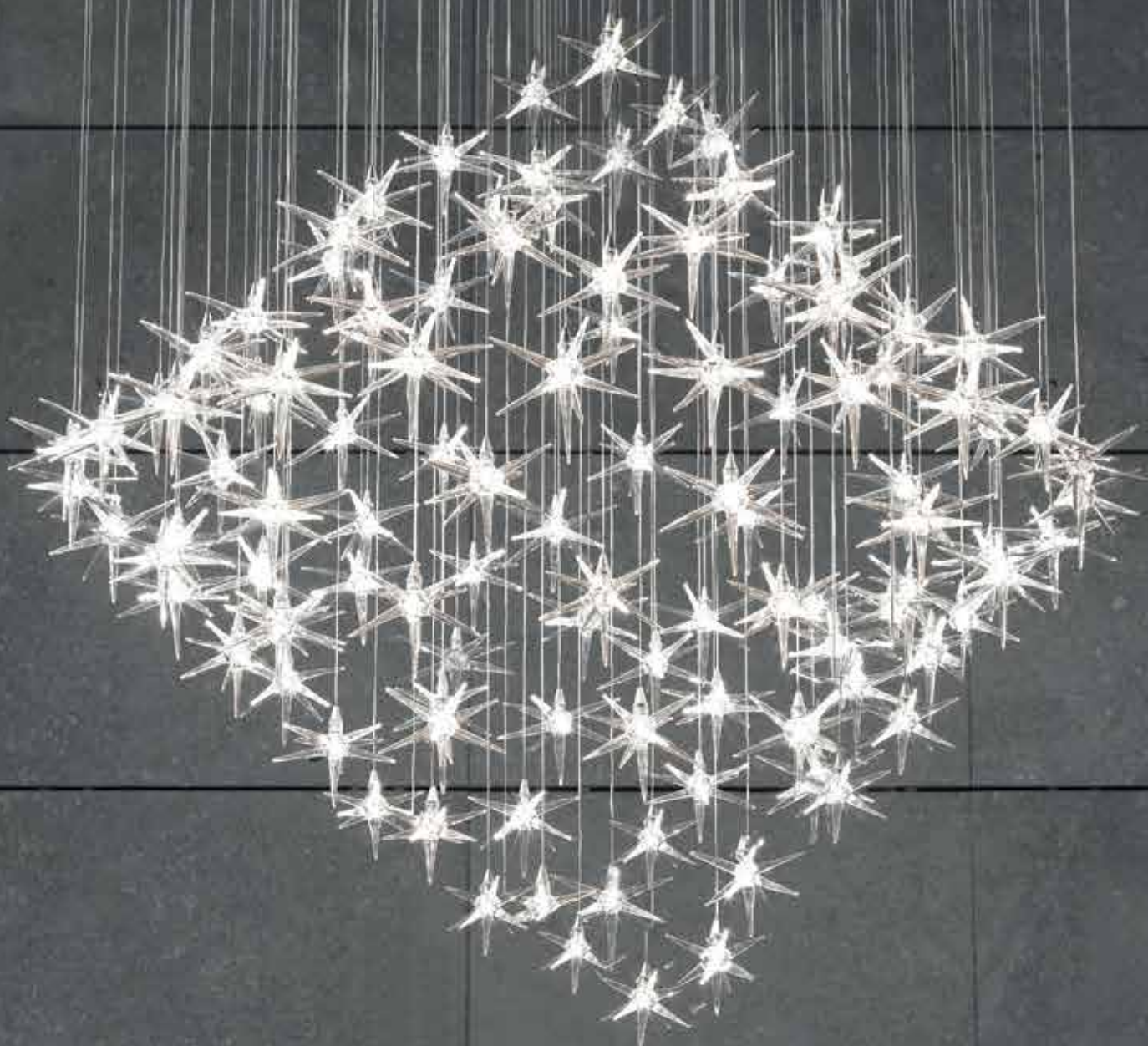

BESPOKE

Bespoke chandelier with ceiling plate in laquered finish
and sparkling stars in transparent or coloured borosilicate glass

Model	Width (mm)	Height (mm)	Lamp
ED 400596	1300	2200	105 x G4 2W 12V LED WW

BESPOKE



BESPOKE

Bespoke chandelier with clear borosilicate glass tubes and high gloss white metal work with SS suspension

Model	Dia (mm)	Height (mm)	Lamp
ED 400593	1000	2500	LED 226W



BESPOKE

Bespoke chandelier with clear glass tubes

Model	Width	Height	Lamp
	(mm)	(mm)	
ED 400594	4000	1000	LED 510W

BESPOKE





ED 400534

Bespoke pendant in handmade borosilicate glass in different colours

BESPOKE

Model	Length (mm)	Width (mm)	Height (mm)	Lamp
ED 400534	1100	450	1000	8 x G9 2.5W LED WW

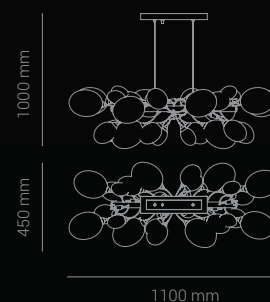



glossy white



transparent red



transparent amber



transparent

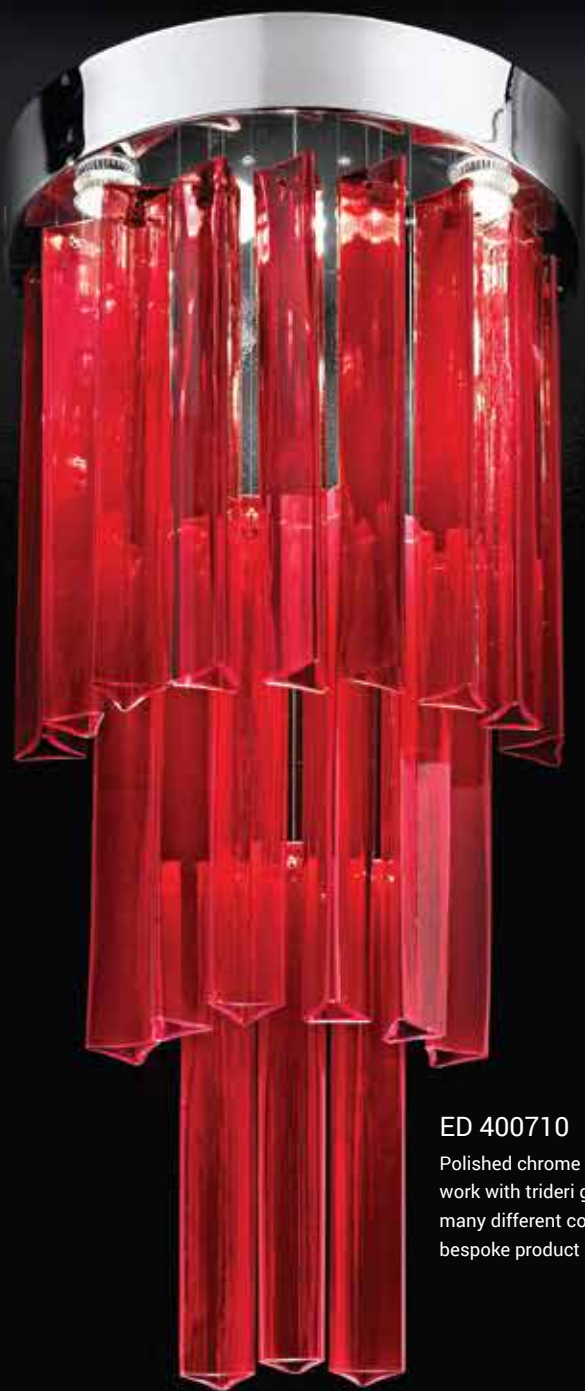

ED 400710

Polished chrome metal frame work with trideri glass available in many different colours to create bespoke product

Model	Width (mm)	Height (mm)	Proj. (mm)	Lamp
ED 400710	450	800	220	4 x GU 10 7 W LED WW



ED 400726

Polished chrome metal frame
work with trideri glass available in
many different colours to create
bespoke product

BESPOKE

Model	Width (mm)	Height (mm)	Lamp
ED 400726	600	1600	8 x E 14 2.3 W LED WW



ED 400677



BESPOKE

Handmade Murano glass shaped in timeless forms with hammered effect available in many different colours to create bespoke product

Model	Width (mm)	Height (mm)	Proj.	Lamp
ED 400677	800	580 - 1230	-	8 x E 27 7.5 W LED WW
ED 400689	380	400	220	2 x E 14 2.3 W LED WW



ED 400689



ED 400692

BESPOKE

Handmade Murano glass shaped in timeless forms with hammered effect available in many different colours to create bespoke product

Model	Dia (mm)	Height (mm)	Lamp
ED 400692	80	500 - 1200	LED 3000°K-9W

BESPOKE

Model	Dia (mm)	Height (mm)	Lamp
ED 400700	800	550 - 1200	LED 3000°K-63W

Handmade Murano glass shaped in timeless forms with hammered effect available in many different colours to create bespoke product





Handmade Murano glass shaped in timeless forms with hammered effect available in many different colours to create bespoke product

BESPOKE

Model	Length	Width	Height	Lamp
	(mm)	(mm)	(mm)	
ED 400708	1400	80	540 - 1200	5 x G9 2.5W LED WW



Model	Length	Width	Height	Lamp
	(mm)	(mm)	(mm)	
ED 400675	2400	610	1500	23 x E 14 2.3 W LED WW

Polished nickel metal work with black shade





BESPOKE

Handmade Murano glass with hammered effect available in many different colours to create Bespoke product

Model	Dia (mm)	Height (mm)	Lamp
ED 400676	1700	1400	36 x E 27 7.5 W LED WW

BESPOKE



BESPOKE

Bespoke pendant in handmade borosilicate glass in different colours

Model	Dia (mm)	Height (mm)	Lamp
ED 400525	540	1900	6 x E 14 2.3 W LED WW + 6 x G9 2.5W LED WW



ED 400525



ED 400713

BESPOKE

Handmade Murano glass in textured finish

Model	Dia (mm)	Height (mm)	Lamp
ED 400713	600	600	32W LED WW

ED 400715

BESPOKE

Handmade Murano glass with textured finish

Model	Width (mm)	Height (mm)	Proj. (mm)	Lamp
ED 400715	150	230	100	18W LED WW

BESPOKE

Handmade Murano glass with textured finish

Model	Length (mm)	Width (mm)	Height (mm)	Lamp
ED 400716	1000	180	500 - 1200	32W LED WW

ED 400716

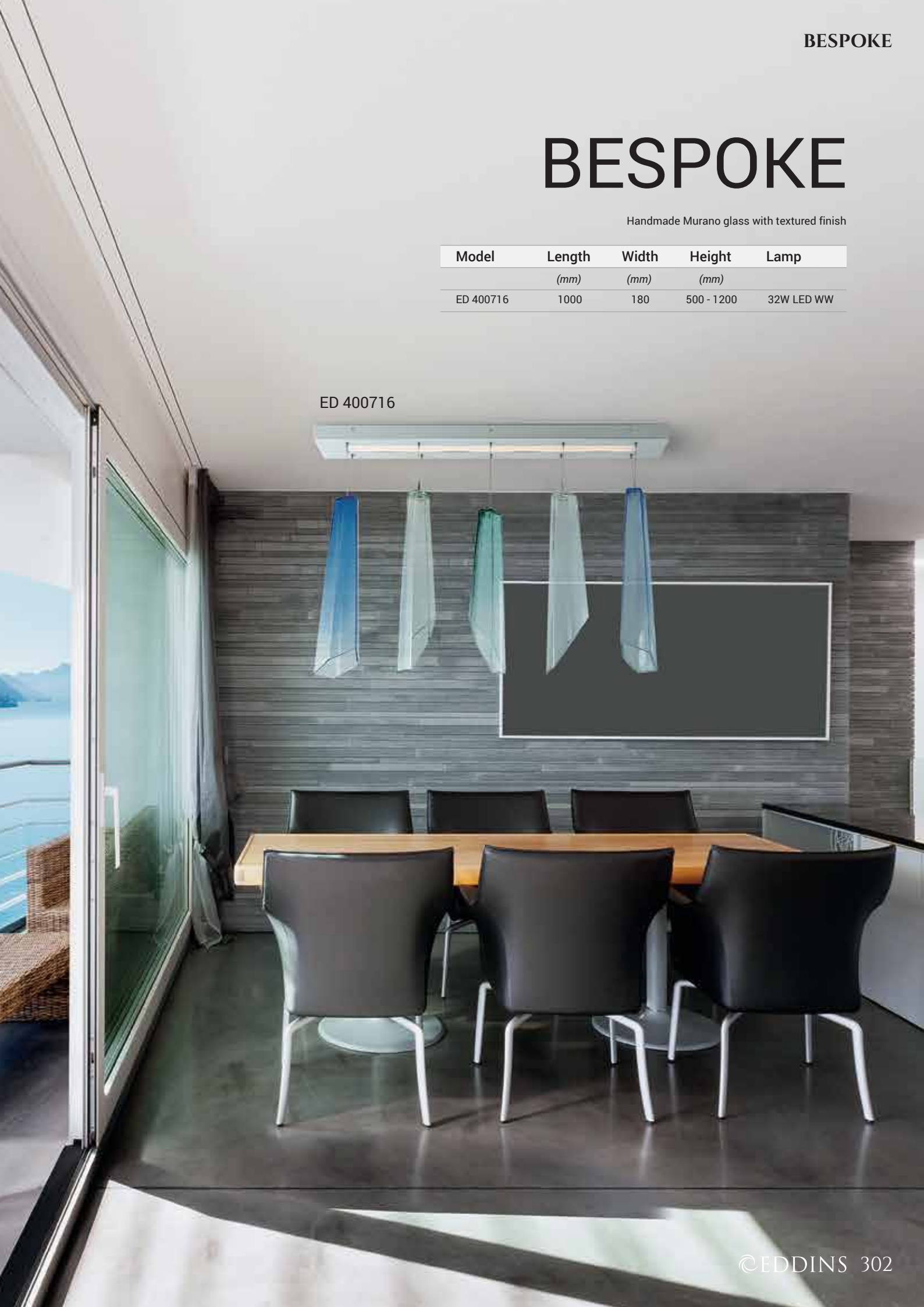

BESPOKE



BESPOKE

Model	Dia (mm)	Height (mm)	Lamp
ED 400536	650	3500	9 x G9 2.5W LED WW + 8 x GU10 40 W (Base)

Finish: Antique bronze metal work with
clear hand made Murano glass

BESPOKE



ED 400717



ED 400718

Handmade Murano glass with hammered effect available in many different colours to create bespoke product

Model	Width (mm)	Height (mm)	Proj. (mm)	Lamp
ED 400717	600	430	-	6 x E 14 2.3 W LED WW
ED 400718	350	270	180	2 x E 14 2.3 W LED WW



Handmade Murano glass with hammered effect
available in many different colours to create bespoke product

Model	Dia (mm)	Height (mm)	Lamp
ED 400719	1000	570 - 1300	6 x G9 2.5W LED WW



BESPOKE

Model	Width (mm)	Height (mm)	Lamp
ED 400532	540	2000	6 x E 14 2.3 W LED WW + 6 x G9 2.5W LED WW



ED 400532

Bespoke pendant in handmade
borosilicate glass in different colours

BESPOKE

Model	Dia (mm)	Height (mm)	Lamp
ED 400533	240	1400	1 x E 14 2.3 W LED WW

ED 400533

Bespoke pendant in handmade
borosilicate glass in different colours

BESPOKE

Bespoke chandelier with ceiling plate in laquered finish
with sparkling stars in transparent or coloured borosilicate glass

Model	Width (mm)	Height (mm)	Lamp
ED 400597	1500	2200	150 x G4 2W 12V LED WW



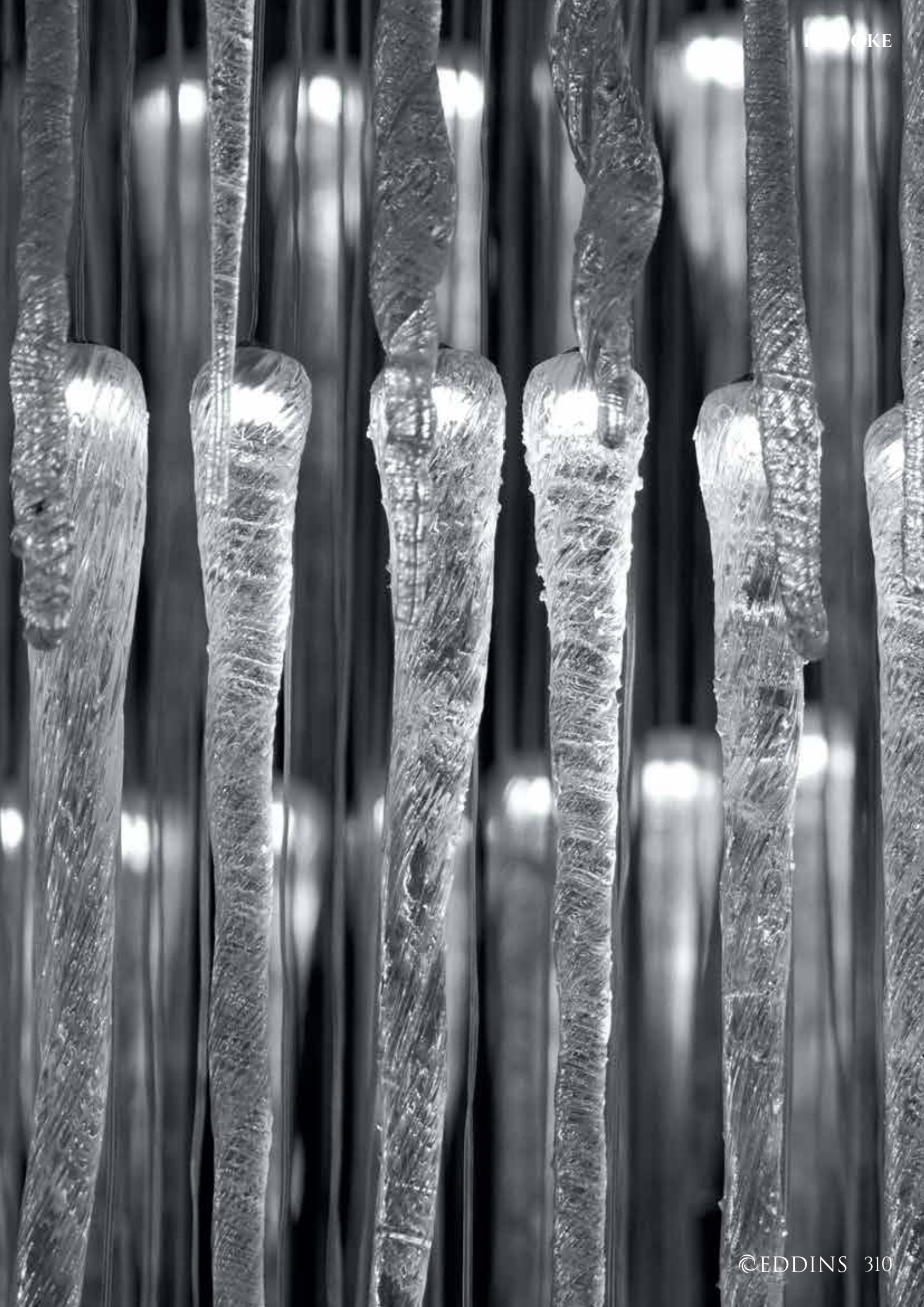



BESPOKE

Bespoke chandelier with hand made ice glass elements

Model	Length (mm)	Width (mm)	Height (mm)	Lamp
ED 400598	3000	1200	2500	178 x G4 2W 12V LED WW

BESPOKE

Bespoke chandelier with hand made ice glass elements

Model	Dia (mm)	Height (mm)	Lamp
ED 400599	1300	2800	450 x G4 2W 12V LED WW

BESPOKE

Finish: Clear blown glass

Model	Dia (mm)	Height (mm)	Lamp
ED 400537	650	3500	9 x G9 2.5W LED WW + 8 x GU10 40 W (Base)

BESPOKE

Finish: Opaque blown glass



Model	Dia (mm)	Height (mm)	Lamp
ED 400758	650	3500	9 x G9 2.5W LED WW + 8 x GU10 40 W (Base)





P 317



P 319



P 321

TULIP



ED 400703

Finish: Black nickel with satin nickel chains
and swarovski elements



ED 400690

Finish: Black nickel with satin nickel chain
and swarovski elements

TULIP

Model	Length (mm)	Width (mm)	Height (mm)	Proj. (mm)	Lamp
ED 400690	-	180	580	120	3 x G9 2.5W LED WW
ED 400703	1160	330	1500	-	18W LED WW



TULIP



ED 400524

Finish: Polished gold metal work with satin nickel chains and Swarovski crystals

TULIP

Model	Dia (mm)	Height (mm)	Lamp
ED 400524	840	400	8 x G9 2.5W LED WW

TULIP



ED 400724

Finish: Polished SS metal work with satin
nickel chains and Swarovski crystals

Model	Length	Width	Height	Lamp
	(mm)	(mm)	(mm)	
ED 400724	2000	330	1500	92W LED WW

TULIP



ED 400538

Finish: Metallic silver / copper finish

TULIP

Model	Dia (mm)	Height (mm)	Lamp
ED 400538	1250	180 - 1500	1 x strip LED 96.5W



ED 400538B
Finish: Metallic silver / copper finish



ED 400538C
Finish: Metallic silver / copper finish

TULIP

Model	Dia (mm)	Height (mm)	Lamp
ED 400538B	620	130 - 1500	1 x strip LED 45.5W
ED 400538C	850	150 - 1500	1 x strip LED 63.5W



THE BOSS IS BACK.
CELEBRATE THE ARRIVAL
OF THE ALL NEW BMW X5





P 325



P 329



P 333



ED 400490

DIONE

Professionally designed range of LED high output Downlight

Die Cast Aluminium Housing

Thermal Heat sink to dissipate the heat for optimal LED performance

High output aluminium reflector

High Optical system for uniform light output

High CRI with long colour consistency LED from CREE / Bridgelux / Citizen

High Luminous Efficacy

Model	Wattage	Lumen	Beam Angle	LED Driver	IP	Application
ED 400490	9W	585 lm	24° / 50°	Remote	20	Hotel Guest Rooms, Public Areas, Retail Outlets, Commercial Offices

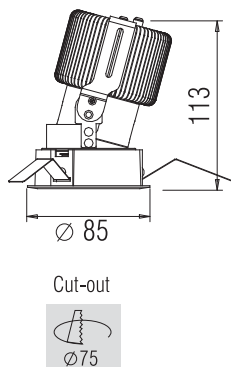

Options :

LED Driver: Standard / 0-10V Dim / DALI Dim

Colour Temperature: 2700k / 3000k / 4000k / 5000k

Finish: White / Black / RAL

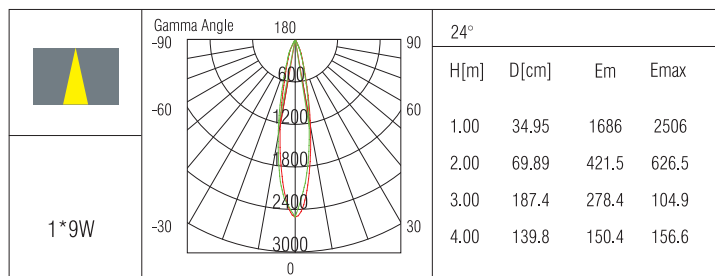



Reflector / Accessories Options



A01



A02



A03



A04



A05



A06

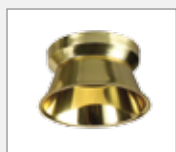

A07



A08



A09



A10



DIONE

Professionally designed range of LED high output Downlight

Die Cast Aluminium Housing

Thermal Heat sink to dissipate the heat for optimal LED performance

High output aluminium reflector

High Optical system for uniform light output

High CRI with long colour consistency LED from CREE / Bridgelux / Citizen

High Luminous Efficacy

Model	Wattage	Lumen	Beam Angle	LED Driver	IP	Application
ED 400491	12W	780 lm	24° / 32° / 50°	Remote	20	Hotel Guest Rooms, Public Areas, Retail Outlets, Commercial Offices

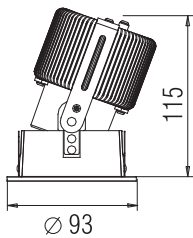

Cut-out



Options :

LED Driver: Standard / 0-10V Dim / DALI Dim

Colour Temperature: 2700k / 3000k / 4000k / 5000k

Finish: White / Black / RAL

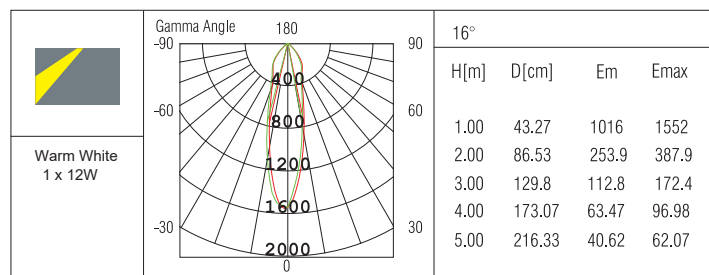



Reflector / Accessories Options



A01



A02



A03



A04



A05



A06

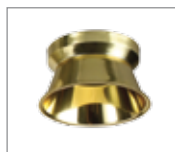

A07



A08



A09



A10

FUSION - FLEX

Ultra thin flexible high output LED strip light
 High CRI index
 Uses compact SMD LEDs
 Self adhesive 3M double sided tape to fix it firmly
 Extruded aluminium profile with opal diffuser



Non Weather Proof

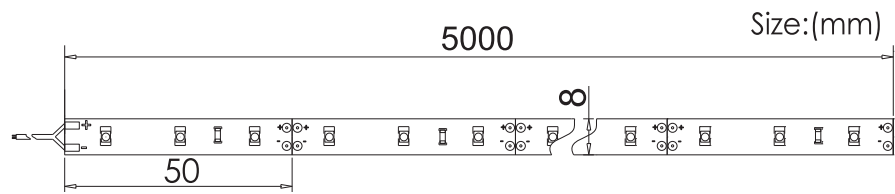

Model	Wattage	Lumen	Beam Angle	LED Driver	IP	Application
ED 400565	4.8W	390 lm/m	120°	Remote	20	Backlit panel, Edge lighting, Indirect
ED 400567	9.6W	790 lm/m	120°	Remote	20	accent lighting, Between glass panels.

Weather Proof

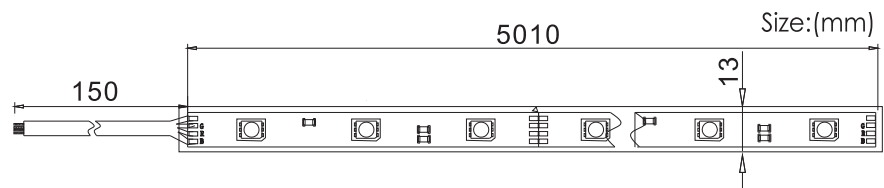

Model	Wattage	Lumen	Beam Angle	LED Driver	IP	Application
ED 400566	4.8W	390 lm/m	120°	Remote	65	Backlit panel, Edge lighting, Indirect
ED 400568	9.6W	790 lm/m	120°	Remote	65	accent lighting, Between glass panels.

Options :

LED Driver: Standard / 0-10V Dim / DALI Dim
 Colour Temperature: 2700k / 3000k / 4000k / 5500k
 Red / Green / Blue / Amber / RGB
 Input Volt (DC): 12V / 24V

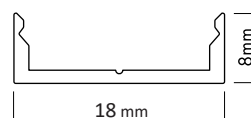

Extruded aluminium
with opal diffuser







ED 400497

DIONE

Unique & Contemporary Designed Wall Recessed Light



ED 400498

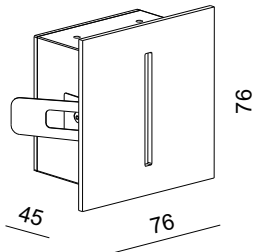
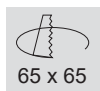

Die Cast Aluminium Construction with installation sleeve
 High Lumen output COB LED from Cree / Bridgelux / Citizen
 Deep LED position for enhanced glare control

Options :

LED Driver: Standard

Colour Temperature: 2700k / 3000k / 4000k / 5000k

Finish: Aluminium Brushed / Black Brushed / Sanded White

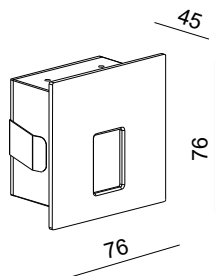
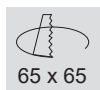

Model	Wattage	LED Driver	IP	Application
ED 400497	3W	Inbuilt	44	Hotel Guest Rooms, Corridors,
ED 400498	3W	Inbuilt	44	Walk Ways, Staircase, Night Light





ED 400495



ED 400496



ED 400494

DIONE

Contemporary Designed Wall Recessed Light

Die Cast Aluminium Construction with installation sleeve
 High Lumen output COB LED from Cree / Bridgelux / Citizen
 Deep LED position for enhanced glare control

Options :
 LED Driver: Standard
 Colour Temperature: 2700k / 3000k / 4000k / 5000k
 Finish: Aluminium Brushed / Black Brushed / Sanded White

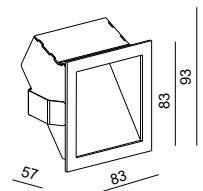
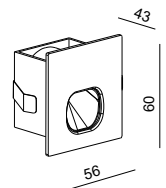
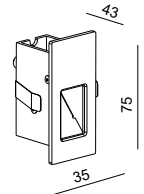

Model	Wattage	LED Driver	IP	Application
ED 400494	3W	Inbuilt	44	Hotel Guest Rooms, Corridors,
ED 400495	3W	Inbuilt	44	Walk Ways, Staircase, Night Light
ED 400496	3W	Inbuilt	44	



FINISH OPTIONS

Metal Finishes

- Polished / Satin Chrome (PC / SC)
- Polished / Satin / Antique Gold (PG / SG / AG)
- Polished / Satin Nickel (PN / SN)
- Polished / Satin / Antique Brass (PB / SB / AB)
- Silver / Oxidized Silver (SI / OS)
- Polished / Satin / Antique Bronze (PBZ / SBZ / ABZ)
- Pewter (PW)

Wood Finishes

- Dark Oak (DO)
- Walnut (WN)
- Pine Wood (PW)
- Rose Wood (RW)
- Dark Ebony (DE)
- Mahogany (MO)
- Natural (NW)
- Cherry Wood (CW)
- Dark Brown (DB)

Glass Finishes

- Opal (OG)
- Frosted (FG)
- Smoked (SG)

Resin Finishes

- Silver Leaf (SL)
- Gold Leaf (GL)
- Burnished Silver (BS)
- Burnished Gold (BG)
- Antique Silver (AL)
- Antique Gold (AG)

Shade Options



Shade color options

FABRIC



Oyster Silk (OSF)



Champagne Silk (CSF)



Auntung Silk (ASF)



Oyster Cotton (OCF)



Beige Cotton (BCF)



Grey Cotton (GCF)



Sandstone Cotton (SCF)



White Linen (WLF)



Beige Linen (BLF)



Wine Red (WRF)



Navy Blue (NBF)



Bottle Green (BGF)

VENEER



White (WVR)



Mahogany (MVR)



Oak (OVR)



Pine (PVR)

INDEX

CODE	PAGE #	CODE	PAGE #	CODE	PAGE #	CODE	PAGE #
ED 400451	233	ED 400498	331	ED 400552	154	ED 400600	277
ED 400452	233	ED 400501	162	ED 400553	150	ED 400601	106
ED 400453	233	ED 400502	167	ED 400554	146	ED 400602	125
ED 400454	234	ED 400503	176	ED 400555	148	ED 400603	102
ED 400455	234	ED 400504	171	ED 400557	245	ED 400604	125
ED 400456	235	ED 400505	212	ED 400558	013	ED 400605	079
ED 400457	235	ED 400506	213	ED 400559	014	ED 400606	081
ED 400458	235	ED 400507	217	ED 400560	015	ED 400607	106
ED 400459	236	ED 400508	051	ED 400561	016	ED 400608	060
ED 400460	236	ED 400509	052	ED 400562	095	ED 400609	025
ED 400461	237	ED 400510	052	ED 400563	096	ED 400610	102
ED 400462	237	ED 400511	209	ED 400564	210	ED 400611	059
ED 400463	238	ED 400512	066	ED 400565	329	ED 400612	029
ED 400464	238	ED 400513	203	ED 400566	329	ED 400613	031
ED 400465	239	ED 400514	165	ED 400567	329	ED 400614	059
ED 400466	239	ED 400515	178	ED 400568	329	ED 400615	033
ED 400467	239	ED 400516	180	ED 400569	215	ED 400616	035
ED 400468	240	ED 400517	184	ED 400570	221	ED 400617	037
ED 400469	240	ED 400518	053	ED 400571	224	ED 400618	098
ED 400470	243	ED 400519	053	ED 400572	225	ED 400619	085
ED 400471	243	ED 400520	054	ED 400573	226	ED 400620	061
ED 400472	243	ED 400521	054	ED 400574	227	ED 400621	077
ED 400473	244	ED 400522	163	ED 400575	227	ED 400622	083
ED 400474	009	ED 400523	164	ED 400576	231	ED 400623	086
ED 400475	010	ED 400524	319	ED 400577	231	ED 400624	062
ED 400476	011	ED 400525	298	ED 400578	254	ED 400625	277
ED 400477	011	ED 400526	262	ED 400579	255	ED 400626	183
ED 400478	012	ED 400527	262	ED 400580	145	ED 400627	153
ED 400479	017	ED 400528	263	ED 400581	147	ED 400628	135
ED 400480	017	ED 400529	263	ED 400582	147	ED 400629	135
ED 400481	018	ED 400530	264	ED 400583	245	ED 400630	083
ED 400482	019	ED 400531	071	ED 400584	269	ED 400631	133
ED 400483	281	ED 400532	307	ED 400585	270	ED 400632	133
ED 400484	092	ED 400533	308	ED 400586	270	ED 400633	134
ED 400485	092	ED 400534	288	ED 400587	273	ED 400634	139
ED 400486	023	ED 400536	304	ED 400588	013	ED 400635	139
ED 400487	023	ED 400537	313	ED 400589	014	ED 400636	140
ED 400488	024	ED 400538	321	ED 400590	015	ED 400637	141
ED 400489	044	ED 400543	244	ED 400591	016	ED 400638	141
ED 400490	325	ED 400544	246	ED 400592	282	ED 400639	142
ED 400491	327	ED 400545	231	ED 400593	285	ED 400640	131
ED 400492	044	ED 400546	071	ED 400594	286	ED 400641	131
ED 400493	051	ED 400547	198	ED 400595	276	ED 400642	132
ED 400494	332	ED 400548	199	ED 400596	284	ED 400643	149
ED 400495	332	ED 400549	091	ED 400597	309	ED 400644	149
ED 400496	332	ED 400550	091	ED 400598	311	ED 400645	151
ED 400497	331	ED 400551	183	ED 400599	312	ED 400646	151

CODE	PAGE #	CODE	PAGE #	CODE	PAGE #	CODE	PAGE #
ED 400647	143	ED 400700	293	ED 400761	110	ED 400840	121
ED 400648	143	ED 400701	170	ED 400763	084	ED 400842	060
ED 400649	144	ED 400702	266	ED 400764	128	ED 400843	123
ED 400650	145	ED 400703	317	ED 400765	111	ED 400844	123
ED 400651	027	ED 400704	280	ED 400768	081	ED 400845	118
ED 400652	046	ED 400705	257	ED 400769	068	ED 400846	101
ED 400653	031	ED 400706	211	ED 400770	122	ED 400847	105
ED 400654	033	ED 400707	249	ED 400774	025	ED 400848	138
ED 400655	045	ED 400708	294	ED 400775	028	ED 400849	102
ED 400656	046	ED 400709	201	ED 400776	029	ED 400850	105
ED 400657	035	ED 400710	289	ED 400778	032	ED 400853	169
ED 400658	037	ED 400711	127	ED 400780	034	ED 400854	127
ED 400659	097	ED 400712	187	ED 400781	036	ED 400859	048
ED 400660	031	ED 400713	300	ED 400782	038	ED 400861	177
ED 400661	045	ED 400714	169	ED 400783	074	ED 400866	172
ED 400662	047	ED 400715	301	ED 400786	064	ED 400869	194
ED 400663	037	ED 400716	302	ED 400787	098	ED 400870	259
ED 400664	047	ED 400717	305	ED 400788	042	ED 400875	087
ED 400665	087	ED 400718	305	ED 400789	085	ED 400876	265
ED 400666	088	ED 400719	306	ED 400790	073	ED 400877	089
ED 400667	065	ED 400720	262	ED 400791	042	ED 400879	195
ED 400668	065	ED 400723	274	ED 400792	063	ED 400880	112
ED 400669	065	ED 400724	320	ED 400793	075	ED 400882	256
ED 400670	089	ED 400726	290	ED 400794	086	ED 400883	183
ED 400671	089	ED 400729	182	ED 400795	196	ED 400887	035
ED 400672	249	ED 400730	191	ED 400798	174	ED 400891	257
ED 400673	197	ED 400731	195	ED 400799	179	ED 400892	116
ED 400674	278	ED 400732	197	ED 400800	076	ED 400895	097
ED 400675	295	ED 400733	205	ED 400804	122	ED 400896	067
ED 400676	296	ED 400734	197	ED 400806	075	ED 400897	045
ED 400677	291	ED 400735	189	ED 400809	110	ED 400900	046
ED 400678	055	ED 400738	187	ED 400810	061		
ED 400679	055	ED 400739	260	ED 400811	179		
ED 400680	057	ED 400740	191	ED 400816	027		
ED 400681	056	ED 400741	173	ED 400818	113		
ED 400682	056	ED 400743	168	ED 400823	078		
ED 400683	057	ED 400744	193	ED 400826	114		
ED 400684	058	ED 400745	193	ED 400827	103		
ED 400685	058	ED 400748	159	ED 400828	117		
ED 400686	048	ED 400749	160	ED 400830	115		
ED 400689	291	ED 400750	161	ED 400831	119		
ED 400690	317	ED 400751	175	ED 400833	117		
ED 400692	292	ED 400752	084	ED 400835	107		
ED 400693	265	ED 400754	156	ED 400836	107		
ED 400694	153	ED 400756	126	ED 400837	137		
ED 400695	152	ED 400758	314	ED 400838	121		
ED 400696	152	ED 400759	079	ED 400839	067		

NOTES

A series of 20 horizontal dotted lines for writing notes.



Terms & Conditions

Definition

The Term "company" used throughout these terms and conditions refers to EDDINS Lighting Limited.

Conditions of Sale

Orders will only be accepted subject to EDDINS Lighting Limited conditions of sale, copies of which are available upon request.

Specifications

EDDINS Lighting Limited makes every effort to ensure the accuracy of the information contained in this brochure. However as our policy is one of continual improvement we reserve the right to amend specifications without notice.

Orders

All Orders are accepted subject to the company's conditions of sale.

The background of the entire page is a dark, almost black, space filled with numerous translucent, glowing droplets of varying sizes. The droplets are primarily in shades of deep blue and purple, with some showing bright highlights that suggest a light source from the side. They appear to be in motion, with some overlapping and others floating independently, creating a sense of depth and fluidity. The overall effect is ethereal and modern.

Eddins Lighting Limited

Conference House, 152, Morrison Street
The Exchange, Edinburgh, EH3 8EB
United Kingdom.

Telephone: + 44 (0) 131 248 2409

Fax: + 44 (0) 131 467 7060

Email: info@eddinslighting.co.uk

exports@eddinslighting.co.uk

Website

www.eddinslighting.co.uk